

DIGITALES ARCHIV

ZBW – Leibniz-Informationszentrum Wirtschaft
ZBW – Leibniz Information Centre for Economics

Shafini Mohd Shafie; Nu'man, A. Harits

Article

Energy storage integration for renewable energy supply in Malaysia : a review

International Journal of Energy Economics and Policy

Provided in Cooperation with:

International Journal of Energy Economics and Policy (IJEEP)

Reference: Shafini Mohd Shafie/Nu'man, A. Harits (2024). Energy storage integration for renewable energy supply in Malaysia : a review. In: International Journal of Energy Economics and Policy 14 (5), S. 242 - 250.

<https://www.econjournals.com/index.php/ijEEP/article/download/16242/8141/39316>.

doi:10.32479/ijEEP.16242.

This Version is available at:

<http://hdl.handle.net/11159/701597>

Kontakt/Contact

ZBW – Leibniz-Informationszentrum Wirtschaft/Leibniz Information Centre for Economics
Düsternbrooker Weg 120
24105 Kiel (Germany)
E-Mail: [rights\[at\]zbw.eu](mailto:rights[at]zbw.eu)
<https://www.zbw.eu/econis-archiv/>

Standard-Nutzungsbedingungen:

Dieses Dokument darf zu eigenen wissenschaftlichen Zwecken und zum Privatgebrauch gespeichert und kopiert werden. Sie dürfen dieses Dokument nicht für öffentliche oder kommerzielle Zwecke vervielfältigen, öffentlich ausstellen, aufführen, vertreiben oder anderweitig nutzen. Sofern für das Dokument eine Open-Content-Lizenz verwendet wurde, so gelten abweichend von diesen Nutzungsbedingungen die in der Lizenz gewährten Nutzungsrechte.



<https://zbw.eu/econis-archiv/termsfuse>

Terms of use:

This document may be saved and copied for your personal and scholarly purposes. You are not to copy it for public or commercial purposes, to exhibit the document in public, to perform, distribute or otherwise use the document in public. If the document is made available under a Creative Commons Licence you may exercise further usage rights as specified in the licence.



Energy Storage Integration for Renewable Energy Supply in Malaysia: A Review

Shafini M. Shafie^{1,2*}, A. H. Nu'man^{3,4}

¹School of Technology Management and Logistics, College of Business, Universiti Utara Malaysia, 06010 Sintok, Kedah, Malaysia,

²Technology and Supply Chain Excellent Institute (TeSCE), School of Technology Management and Logistics, College of Business, Universiti Utara Malaysia, 06010 Sintok, Kedah, Malaysia, ³Department of Industrial Engineering, Faculty of Engineering, Universitas Islam Bandung, Jalan Tamansari No. 20 Bandung 40116, West Java, Indonesia, ⁴Department of Management, Faculty of Economic and Business, Universitas Islam Bandung, Jalan Tamansari No. 20 Bandung 40116, West Java, Indonesia. *Email: shafini@uum.edu.my

Received: 10 March 2024

Accepted: 17 July 2024

DOI: <https://doi.org/10.32479/ijeep.16242>

ABSTRACT

Malaysia intends to increase the share of renewable energy (RE) in its installed power capacity from the current 23%, or 8.5 GW, to 40%, or 18.0 GW, by 2035. Renewable energy sources, specifically solar and biogas, are unpredictable and subject to sudden changes due to weather conditions and feedstock availability. Furthermore, their integration with the current conventional plants is complicated. In relation to this, deploying energy storage has become the main agenda under the Renewable Energy Roadmap to achieve 40% installed capacity by 2035. When selecting the most adequate energy storage system, the technological, environmental and economic aspects need to be considered. Therefore, the purpose of this article is to review the current state of energy storage and the renewable energy situation in Malaysia. The significance of this paper is that it encourages RE consumption in Malaysia in parallel with the government's target due to the deployment of energy storage in the energy supply system. It can serve as a guideline for policymakers in their penetration of the renewable energy sector.

Keywords: Energy Storage, Renewable Energy, Malaysia, Integration

JEL Classifications: Q400, Q420

1. INTRODUCTION

The Malaysian energy industry landscape is under threat due to its reliance on coal imports, the exhaustion of available local gas resources and the slow progress of energy from the penetration of renewable sources. Malaysia has drastically increased its renewable energy (RE) growth rates. The country aims to increase the RE share in its power installed capacity from 23%, or 8.5 GW, to 31%, or 12.9 GW, in 2025 and 40%, or 18.0 GW, in 2035 (SEDA, 2021a). The Minister of Energy and Natural Resources stated that the agreements for more than 7,000 MW of coal power stations will end by 2033. Coal will be replaced mainly by gas and RE, as Malaysia will not be extending the operation of

these plants to lower the country's carbon emissions (Ministry of Economy, 2023a). Despite this, serious action must be taken to accelerate RE installation in Malaysia's power sector. As a flexible solution, energy storage promotes the adoption of intermittent RE sources. Energy storage systems (ESS) are always needed to account for the continual fluctuations of renewable sources (Saha et al., 2022). As mentioned (Ministry of Economy, 2023a), energy storage becomes the flagship catalyst project under RE transition in developing utility-scale ESS to enable higher penetration of variable RE in Malaysia. As reported in the Malaysia Renewable Energy Roadmap (MyRER), solar photovoltaic (PV) has the potential to generate 269 GW, followed by 13.6 GW from large hydropower resources, 3.6 GW from biogas and 2.73GW from

small hydropower and geothermal resources. Approaches to managing the electrical system will need to be modified in response to changes towards RE generation. Energy sources from solar and biogas are unpredictable and subject to sudden changes due to weather conditions. As a result, ESS provides a more effective solution by acting as a storage unit for managing irregular subsequent generations from present sources RE (Lee et al., 2023). Furthermore, their integration with the current conventional plants is complicated. Relevantly, energy storage has become a compulsory component to be installed. According to the Twelfth Malaysia Plan (RMK12) (under the strategy of enhancing the energy sector), the adoption of new energy storage technologies will be further promoted in RE. As MyRER indicated (SEDA, 2021a), energy storage has become a new solution to ensure the system's stability for RE consumption.

ESS can provide relevant support to the electrical system by integrating renewable energy sources, especially solar PV. According to MyRER (SEDA, 2021b), one of the key actions under the new solutions and resources pillar is to determine and implement appropriate execution plans for ESS, including decentralised and centralised options (SEDA, 2021a). Malaysia has announced plans to adopt up to 500 MW of battery storage technology from 2021 to 2039 (Suruhanjaya Tenaga, 2020). Biogas and battery energy storage systems (BESS) are examples of technologies that are still in the early stages of deployment in Malaysia. In determining their suitability for Malaysian conditions, research projects or small-scale pilot projects must be conducted (Abdullah et al., 2019). According to Liu et al. (2023), evaluating the integration of energy storage from both sustainability and economic perspectives is essential.

As previously stated, it is crucial to preserve excessive RE through suitable technology for energy storage (Martins et al., 2020). Economic, environmental and social factors must be considered when deciding on the best ESS. As a result, the selection process takes into account available energy resources as well as national or international political and strategic issues, particularly when it comes to RE generation and consumption. Additional factors include the particulars of ESS to be implemented, technical feasibility, expenses and returns on investment, simplicity and security of operation, storage effectiveness comprising durability and storage, and the total capacity decline over time (Amir et al., 2023). The energy storage arrangement structures for incorporated power plants at various scales are geographically dependent (Liu et al., 2023). As stated in Chisale et al. (2023), boosting a combination of RE sources with energy storage applications is a difficult task because it is site-specific and dependent on the location, the economy and environmental conditions, demand for load, and accessible RE sources. The energy storage model based on Malaysian conditions is required to assist the decision-maker in considering an optimised model that emphasises environmental and economic perspectives.

2. RENEWABLE ENERGY IN MALAYSIA

Malaysia currently uses solar, biomass and biogas in its electricity mix to generate RE. Figure 1 indicates the trend

Figure 1: Trend of electricity generation based on renewable energy sources

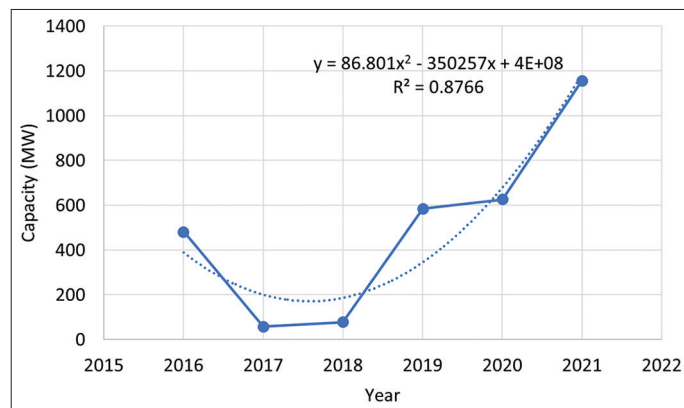

of electricity generation based on RE sources. RE generation appears to have increased in recent years, owing to Malaysia's solar energy development. The solar energy programmes include self-consumption (SELCO), net energy metering (NEM) and large-scale solar (LSS). Implementing policies and organising RE programmes gradually become the cornerstones of this successful journey. Figure 2 is an infographic related to Malaysia's programmes and policies towards renewable energy consumption (SEDA, 2021b). Parallel to these, Figure 3 shows a solar power plant installation in Malaysia for 2023.

Malaysia's roadmap towards 40% RE capacity in 2035 targets about 7,280 MW (30%) from solar and approximately 1,404 MW (7.8%) from biogas and biomass. Figure 4 depicts the combination of RE capacity required to meet the target in 2035. These energy resources will become the most reliable RE mix in the future due to their availability. Solar power has been recognised as the most promising RE source in Malaysia's bright and sunny tropical climate. Figure 5 shows solar and biogas RE resources in Malaysia.

The increasing amount of RE in electricity generation requires exploring the details of energy storage. These ESS will allow surplus electricity produced from RE to be stored for further utilisation, thereby ensuring grid reliability. The application concept of energy storage is illustrated in Figure 6. Here, excess electricity is stored to be consumed later or at night.

Relevantly, energy storage technology is the most competent technology to be explored. With that in mind, Malaysia plans to implement ESS powered by batteries with an entire capacity of approximately 500 MW beginning in 2030. These battery energy storage systems (BESS) will enable the storage of excess energy generated by solar panels for later use. This concept is particularly useful for solar energy installations, as energy generation from such installations depends on the presence of sunlight. It is important to consider that the Net Energy Metering 3.0 (Net Offset Virtual Aggregation) Programme (NEM NOVA Programme) recently anticipates and permits the deployment of BESS in solar energy systems. This declaration has been included in the Energy Commission Malaysia's regulations for the NEM NOVA scheme. It would seem that the first steps to encourage the use of BESS have been taken before. It has also been determined that the

Figure 2: Infographic related to the programmes and policies towards renewable energy consumption in Malaysia

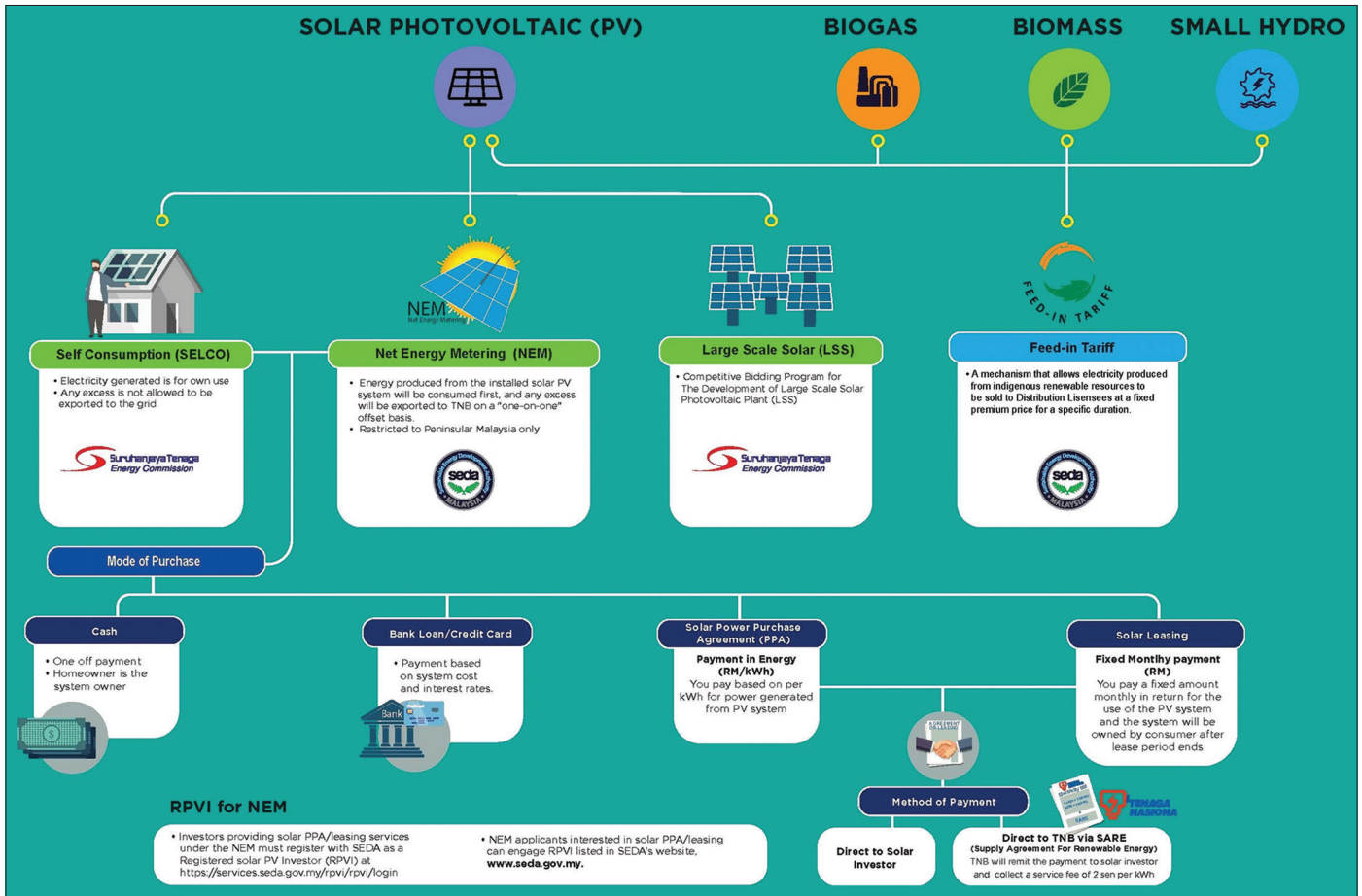
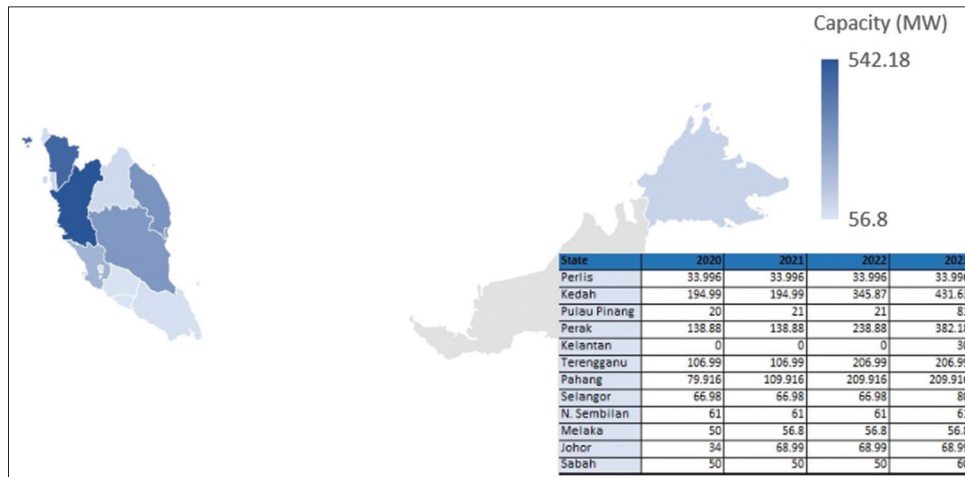

Figure 3: Solar power plant installation in Malaysia for 2023



most significant improvements require incorporating additional components into the most efficient possible power generation facility (Javid et al., 2021).

3. ENERGY STORAGE DEVELOPMENT

One essential technology for implementing the energy transition and expanding global energy access is energy storage. BESS applies various technologies in power systems undergoing rapid

development as policymakers in many countries increasingly propagate towards more intermittent renewable electricity generation that produces new demands on the system grid. BESS is an easy technique for storing energy for later use. Energy storage is more than just combining intermittent solar and biogas output. Battery solutions, which can be executed quickly and precisely, can be utilised to improve the whole grid's efficiency and resilience, irrespective of subsequent generations' sources. Additionally, battery prices are decreasing and energy storage markets are growing more rapidly than expected. Figure 7 shows

global storage deployment projections by country from 2018 to 2030 (Motyka et al., 2018).

There are five types of energy storage systems accessible and commercially used worldwide: (1) pumped-storage hydroelectric;

(2) batteries (electrochemical); (3) solar electric with thermal energy storage; (4) compressed-air storage; and (5) flywheels. Further ESS in development, research and commercialisation, include capacitors and super-conducting magnetic storage. Electrolysis produces hydrogen, which is able to produce electricity and store

Figure 4: RE capacity combination to achieve the target in 2035

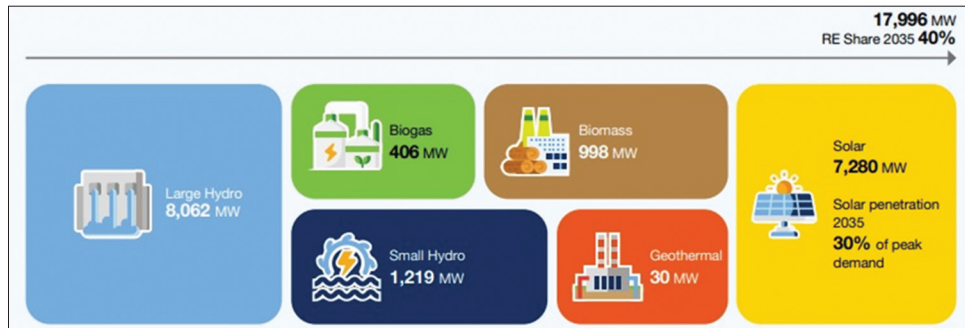

Figure 5: (a and b) Solar and biogas renewable energy resources in Malaysia

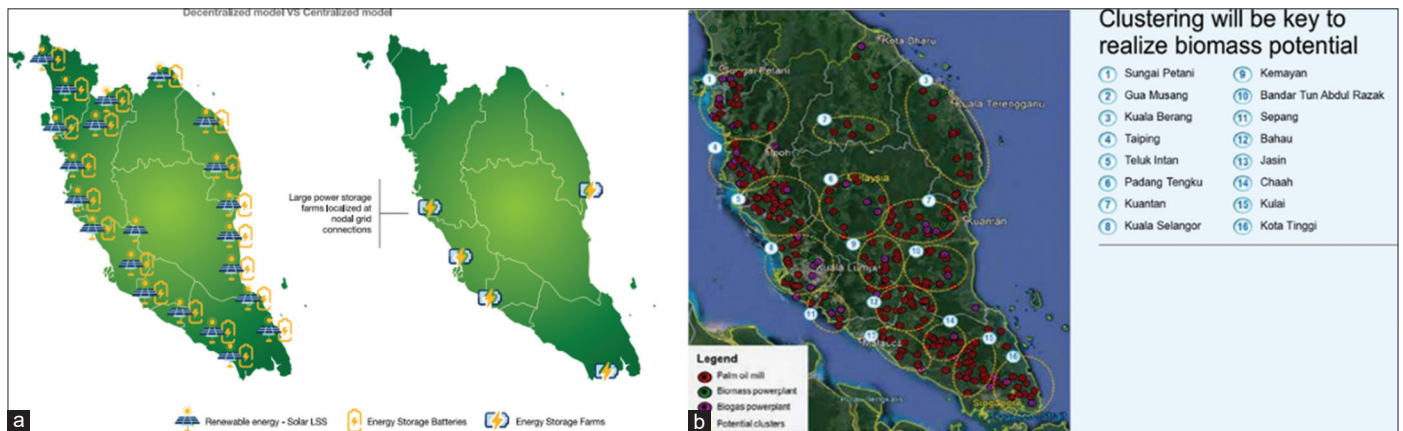

Figure 6: Application concept of energy storage

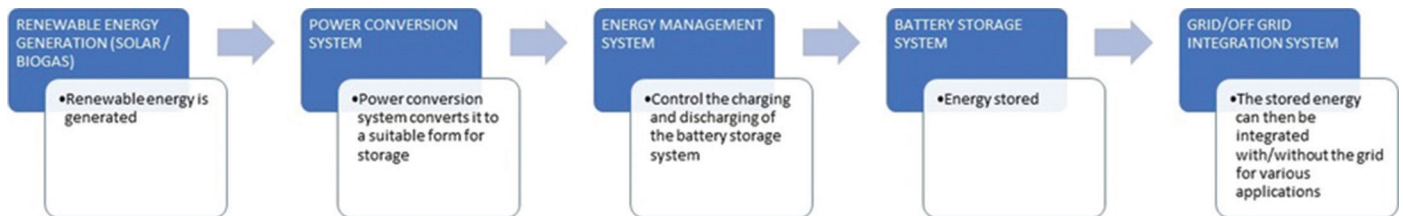
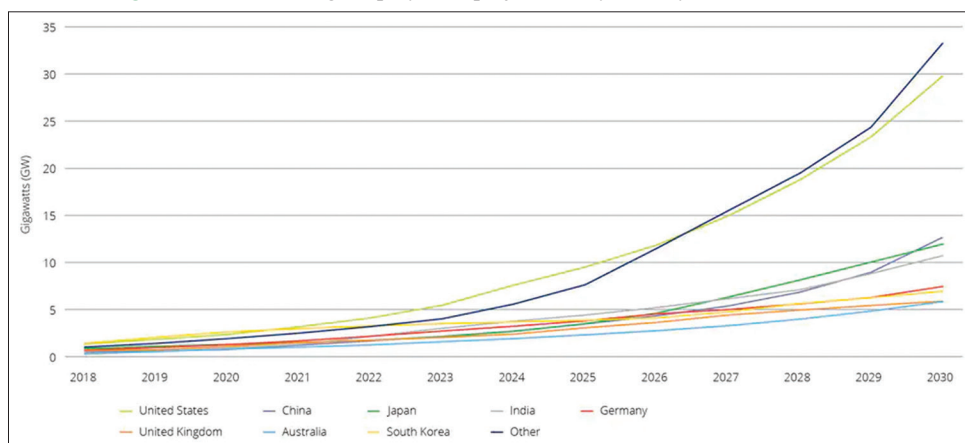

Figure 7: Global storage deployment projections by country from 2018 to 2030



energy. Thermal ice-storage systems utilise electricity at night to create ice in a huge vessel. This ice can be utilised to cool buildings throughout the day, reducing the need for costly electricity purchases during peak hours. For example, to supply electricity to an off-grid submission or to supplement a peak demand. Several energy storage systems include the blue battery system, air-compressed energy storage, lead acid batteries and lithium-ion batteries. Figure 8 shows size classifications of energy sources and energy storage (He et al., 2023). Thermal, mechanical, chemical, electrochemical, electrical and magnetic fields are all potential energy storage methods. Energy can also be preserved in a combination of two separate kinds. Large-scale energy storage options comprise batteries, hydrogen energy storage, pumped-hydro storage, thermal energy storage, compressed energy storage and gravity energy storage.

3.1. Battery Energy Storage

Battery energy storage types include lead-acid batteries, lithium-ion (Li-ion) batteries, flow batteries, molten sodium (Na) batteries, nickel-cadmium (Ni-Cd) batteries and some advanced batteries. Lead-acid batteries are the earliest, most established and most affordable form of battery that can be recharged (Yang et al., 2024). This kind of energy storage has constraints because of its low effectiveness and short life-cycle time (Zhang et al., 2023). Nevertheless, this battery energy storage is already incorporated into the renewable energy integration system (Yang et al., 2024). Li-ion batteries have been developed to be flexible, allowing them to be incorporated easily into a large-scale energy storage system.

This type of battery provides good performance, but caution should be exercised regarding safety (Christiansen and Murray, 2015). The flow battery is extremely distinct from ordinary batteries. The battery system consists of two storage tanks with two distinct aqueous electrolytes and a reactor. Molten batteries are primarily proved and produced in Japan. This type of battery has almost four times the capacity and power output of a standard lead-acid battery. Nevertheless, nickel-cadmium batteries have not yet been commercially viable and are unsuitable for large-scale energy output. Normally, battery energy storage is not used to substitute grid power completely. Instead, it is used to offer short-term resolutions in applications where access to the grid power is intermittent, or the use of a generator is inappropriate due to certain constraints like noise or pollution. In 2020, investment in battery

storage increased by nearly 40%, reaching USD5.5 billion (Teo and Go, 2021). Furthermore, as RE consumption grew, the expenditure on grid-scale batteries increased by more than 60% (Aziz, 2021). To increase solar energy consumption, Malaysia intends to implement BESS with a total capacity of 500 MW beginning in 2030 (Ministry of Energy and Natural Resources, 2021). The most efficient storage technologies for solar photovoltaic are 1 MWh zinc bromide, 1 kWh lithium-ion and 100 kWh lithium-ion battery systems, which are limited to specific locations and properties (Laajimi and Go, 2019).

3.2. Hydrogen Energy Storage

A surplus of RE can be converted into hydrogen, which is subsequently stored to generate electricity as demanded. There are three types of hydrogen storage: compressed gas, liquid hydrogen and solid-state storage (Hassan et al., 2023). Although hydrogen energy storage is still in its early stages, it provides significant prospects for larger climate change mitigation initiatives. Despite the ineffectiveness of return energy conversions, hydrogen grows as an attractive option for maintaining energy from renewable sources and storage energy for applications off the grid.

3.3. Pumped-hydro Storage

Pumped-hydro storage is probably the wisest, most effective and durable technological advance. Pumped-hydro energy storage plays an important role for power lines that rely heavily on RE sources. It optimises energy use and reduces surplus electricity releases (Naval et al., 2023). This type of energy storage may function successfully for a long time, though batteries, for example, degrade within a less lengthy period.

3.4. Thermal Energy Storage

Thermal energy storage is the storage and retrieval of heat for future usage. The long-term economic feasibility of a thermal energy storage system is heavily affected by its maintenance and operation expenses (Barbhuiya et al., 2024).

3.5. Compressed-air Energy Storage

Compressed-air energy storage is considered one of its most ensuring energy storage technologies, capable of providing 100 MW of capacity at affordable prices (Niu et al., 2024). The compressed-air energy storage system consists of a compressor, air storage room, expander and additional primary elements. A surplus of electrical energy propels the compressor's motor, compressing low-pressure gas to high-pressure air and storing it within the air storage room. When electricity is required, high-pressure air is expelled from the storage room, driving the expander to generate electricity (Li et al., 2023).

3.6. Gravity Energy Storage

Gravity energy storage technology is an innovative large-scale mechanical energy storage system identical to the frequently employed pumped-hydro storage. This type of storage is especially appealing for seasonal use (Tong et al., 2023).

Several major initiatives and policies revealed in the last few years are projected to speed up global energy storage installation, which is developing in recent progress. Nevertheless, a misconception

Figure 8: Size classifications of energy sources and energy storage

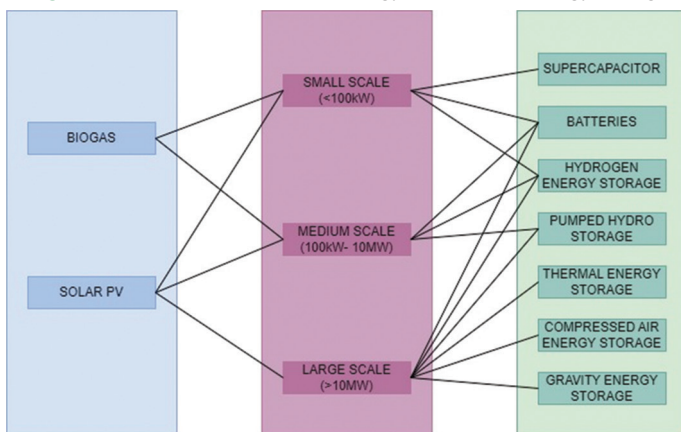

exists about the value of energy storage due to its greater expense compared to fossil fuel. A knowledge gap is present when developing and enhancing grid design for storage installation. Despite several ASEAN countries taking steps to take the latest advances in energy storage, particular strategies to encourage further adoption of these storage systems are inadequate. A study is necessary to determine the technological possibilities for decentralised energy storage and to organise their primary characteristics considering various variables, such as expenses, capacity for storage, security of operation and sustainability, among other issues. A comprehensive multidimensional analysis that considers environmental, technical, economic and social factors is required to choose the best technology option.

The government has a critical role in determining the success of RE and energy storage in Malaysia. Due to this concern, the Sustainable Energy Development Authority Malaysia (SEDA), in its Renewable Energy Roadmap, highlights the following key points regarding energy storage development under the Energy Storage Pillar (SEDA, 2021):

- New battery chemistries and materials
- Green hydrogen production through electrolysis
- Fuel cells
- Other energy storage technologies (e.g., compressed air, heat storage).

As mentioned (Ministry of Economy, 2023b), energy storage has become the flagship catalyst project under RE transition in creating a utility-scale ESS to enable higher penetration of variable RE in Malaysia. Malaysia has made efforts to integrate several programmes and policies that serve as the foundation for developing policies and regulations that encourage RE growth. All of Malaysia's policies and programmes promoting RE development are listed below:

- The Twelfth Malaysia Plan (2021–2025): High-Growth, High-Value (HGHV) Industry Based on Energy Transition.
- KEGA 11: Renewable energy-Malaysia has the potential to progress far in this activity by facilitating new technology use, providing pilot localities and offering funding for RE generation.
- 10-10 MySTIE Framework: Energy Socio-economic driver-Decentralised electricity grid.
- Malaysia Renewable Energy Roadmap (2035) under new solutions and resources pillar.
- The Twelfth Malaysia Plan (2021–2025) under Theme Three (Advancing Sustainability) focuses on advancing green growth and enhancing energy sustainability.
- Parallel to SDG 7 (Affordable and Clean Energy), which ensures access to affordable, reliable, sustainable and modern energy for all.
- Sustainable Energy Development Authority Act (Act 726) in 2011.
- Renewable Energy Act in 2011.
- Renewable Energy Feed-In Tariff (FiT) Programme in 2011.
- Sustainability Achieved Via Energy Efficiency 4.0 (SAVE) programme in 2011.
- National Renewable Energy Policy and Action Plan (NREAP) in 2010.
- National Green Technology Policy in 2009.

All the state policies are related to RE development and prove that the Malaysian government is serious about sustainable energy development to combat climate change. The energy transition connected to energy storage applications is another point of emphasis in the current RMK12. Therefore, this issue of energy storage will become an essential part of RE contribution in Malaysia. Related to this, Malaysia plans to adopt up to 500 MW of battery storage technology (2021–2039) and thus possibly increase the RE share up to 40% (18 GW) of electricity generation in 2035.

3.7. Centralised and Decentralised Energy Storage Systems

Centralised and decentralised energy systems are truly different in terms of coordination, whereby the coordination by a system operator in real time refers to a centralised system. Figure 9 illustrates the structure of centralised and decentralised energy systems. A significant portion of the power grid network relies on centralised energy generation, in which electricity is produced on a large scale from centrally located facilities, particularly in industries involving fossil fuel-based electricity generation (Liu et al., 2017). The installation of large-scale PV plants with BESS in grid networks or a centralised system will help distribution companies manage peak load demand, maintain voltage and eliminate technical losses (Boruah and Chandel, 2024). Nevertheless, more research is required to fully understand the technical and economic implications of integrating large-scale PV and storage systems into the grid network, followed by consumers and distribution companies' shared use of such systems (Boruah and Chandel, 2023). The study by Wali et al. (2024) found that the grid-connected BESS market is diverse, with no key players or inventors. Nevertheless, in terms of published output from connected energy storage grids, the United States currently leads the world, followed by China. The study on energy storage in a grid-connected RE system with solar and wind energy sources discovered that improving discharge efficiency is the most significant way for energy storage developers to reduce levelised costs (Farah and Andresen, 2024). These challenges encompass technical aspects, like determining storage capacity sizing and regulatory considerations, including ownership, safety regulations, sustainability and commercial viability. Mongolia has installed its first grid-connected ESS, with an 80-MW capacity. With these implementations, a few key factors are involved: (1) determining the capacity of energy storage; (2) selecting the best location; (3) listing performance requirements and (4) creating operational guidelines (Sakai, 2021).

Figure 9: Structure of centralised and decentralised energy systems

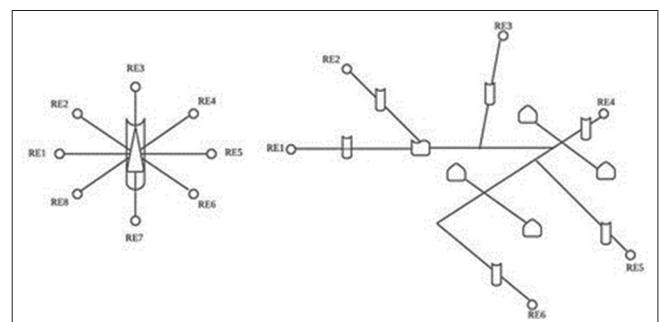

Figure 10: Renewable generation expansion strategies

The decentralised system market for electricity requires substantially less coordination before transmission. Decentralised energy production refers to small-scale electricity generation ranging from 1 kW to 250 MW (Ogunjuyigbe et al., 2016). In contrast with the typical centralised generation, decentralised generation is situated near electricity consumers. It is not directly linked to the major transmission network and is not centralised dispatched. For instance, introducing innovative innovations like solar PV, energy storage and demand response is difficult in a centralised electricity market (Ahlqvist et al., 2022). As a result, decentralisation in the electricity sector is the primary step towards implementing RE in the country, and it has been growing rapidly due to environmental issues (Pelosi et al., 2023). The varieties of RE resources cause them to become distinct from conventional energy generation. Variable RE differs from conventional power generation in several ways, including its compact and flexible generator, non-synchronous mechanism and unpredictable characteristics (Erdiwansyah et al., 2021). Nevertheless, the technologies designated for this type of system may differ by geographical area and be contingent upon local circumstances (McPherson and Stoll, 2020). One of the most significant issues to consider when developing to meet long-term electricity demand is whether to produce electricity using a centralised or decentralised approach (Toloo et al., 2022). Figure 10 depicts centralised and decentralised renewable generation growth strategies.

The effectiveness of energy storage implementation depends not only on technological advancement but also on preliminary research from an environmental and economic standpoint. The Life Cycle Assessment (LCA) can provide decision-makers with environmental performance information on energy systems using a standardised, whole-system, transparent approach based on the best available science (Stougie et al., 2019). With the increasing concern about climate change, optimising the operation strategies of multiple energy systems, considering the low-carbon characteristic, is highly desirable. Economic benefits are frequently used to evaluate the performance of the coordination, either in cooperative or non-cooperative actions. The success of energy storage employment highly depends on economic potential and profitability in electricity markets (Xiao et al., 2022). Therefore, understanding the cost and environmental implications of centralised and decentralised RE systems requires a comprehensive assessment of the potential RE configurations that can arise locally. Optimal designs and configurations are vital when RE technologies are introduced into the power system

(Ahmadi et al., 2021). Energy storage implementation research will positively impact society, academia, government, industry and the environment. The impact on society is to create jobs, generate income and provide educational opportunities, particularly in rural areas that benefit from RE access and empowerment. Furthermore, it improves energy security by reducing reliance on fossil fuel imports. It encourages more credible and original research in this field, particularly on ESS, which is beneficial from an academic standpoint. The positive side of the government will boost RE use, consistent with government policy shifting towards green energy. This situation supports the government's goal of 40% RE generation by providing a framework for policymakers to implement more affordable and clean energy options. Regardless of the high initial costs, projected savings in the coming years will position the energy storage market as a significant contributor to increased investment in the RE sector and the low-carbon economy. These effectively capture and utilise renewable energy sources, transforming the green energy industry. Finally, implementing an ESS will reduce greenhouse gas emissions and air pollution by enabling more RE generation while avoiding the use of fossil fuels.

4. CONCLUSION

Malaysia has a huge potential for using renewable energy as its primary source of electricity generation in the near future. Limitations in renewable energy, particularly high costs, seasonal availability, technology application, stakeholder involvement and government support, are the most important factors to consider. Energy storage appears to be the most efficient method to optimise renewable energy consumption. The choice of energy storage type based on local conditions should be considered carefully. When choosing the best energy storage system, it is important to consider not only technological but also environmental and economic factors. Deployment of energy storage in the supply system can help achieve the government's target towards renewable energy consumption in Malaysia.

REFERENCES

- Abdullah, W.S.W., Osman, M., Ab Kadir, M.Z.A., Verayah, R. (2019), The potential and status of renewable energy development in Malaysia. *Energies*, 12(12), 2437.
- Ahlqvist, V., Holmberg, P., Tangerås, T. (2022), A survey comparing centralized and decentralized electricity markets. *Energy Strategy Reviews*, 40, 100812.
- Ahmadi, M., Adewuyi, O.B., Danish, M.S.S., Mandal, P., Yona, A., Senjyu, T. (2021) Optimum coordination of centralized and distributed renewable power generation incorporating battery storage system into the electric distribution network. *International Journal of Electrical Power and Energy Systems*, 125, 106458.
- Amir, M., Deshmukh, R.G., Khalid, H.M., Said, Z., Raza, A., Muyeen, S.M., Nizami, A.S., Elavarasan, R.M., Saidur, R., Sopian, K. (2023), Energy storage technologies: An integrated survey of developments, global economical/environmental effects, optimal scheduling model, and sustainable adaption policies. *Journal of Energy Storage*, 72, 108694.
- Aziz, A. (2021), Special Report on the 12th Malaysia Plan 2021 - 2025: The Malaysian Case for Carbon Tax. The Edge Malaysia. Available

- from: <https://theedgemalaysia.com/article/special-report-12th-malaysia-plan-2021-2025-malaysian-case-carbon-tax>
- Barbhuiya, S., Das, B.B., Idrees, M. (2024), Thermal energy storage in concrete: A comprehensive review on fundamentals, technology and sustainability. *Journal of Building Engineering*, 82, 108302.
- Boruah, D., Chandel, S.S. (2023), A comprehensive analysis of eight rooftop grid-connected solar photovoltaic power plants with battery energy storage for enhanced energy security and grid resiliency. *Solar Energy*, 266, 112154.
- Boruah, D., Chandel, S.S. (2024), Techno-economic feasibility analysis of a commercial grid-connected photovoltaic plant with battery energy storage-achieving a net zero energy system. *Journal of Energy Storage*, 77, 109984.
- Chisale, S.W., Eliya, S., Taulo, J. (2023), Optimization and design of hybrid power system using HOMER pro and integrated CRITIC-PROMETHEE II approaches. *Green Technologies and Sustainability*, 1(1), 100005.
- Christiansen, C., Murray, B. (2015), Energy Storage Study Funding and Knowledge Sharing Priorities. Australia: AECOM Australia Pty Ltd. Available from: <https://arena.gov.au/assets/2015/07/aecom-energy-storage-study.pdf> [Last accessed on 2024 Jul 28].
- Erdiwansyah, E., Mahidin, A.T., Husin, H., Nasaruddin, S., Zaki, M., Muhibbuddin, M. (2021), A critical review of the integration of renewable energy sources with various technologies. *Protection and Control of Modern Power Systems*, 6(1), 3.
- Farah, S., Andresen, G.B. (2024), Investment-based optimisation of energy storage design parameters in a grid-connected hybrid renewable energy system. *Applied Energy*, 355, 122384.
- Hassan, Q., Sameen, A.Z., Salman, H.M., Jaszczur, M., Al-Jiboory, A.K. (2023), Hydrogen energy future: Advancements in storage technologies and implications for sustainability. *Journal of Energy Storage*, 72, 108404.
- He, Y., Guo, S., Dong, P., Zhang, Y., Huang, J., Zhou, J. (2023), A state-of-the-art review and bibliometric analysis on the sizing optimization of off-grid hybrid renewable energy systems. *Renewable and Sustainable Energy Reviews*, 183, 113476.
- Javid, I., Chauhan, A., Thappa, S., Verma, S.K., Anand, Y., Sawhney, A., Tyagi, V.V., Anand, S. (2021), Futuristic decentralized clean energy networks in view of inclusive-economic growth and sustainable society. *Journal of Cleaner Production*, 309, 127304.
- Laajimi, M., Go, Y.I. (2019), Energy storage system design for large-scale solar PV in Malaysia: Technical and environmental assessments. *Journal of Energy Storage*, 26, 100984.
- Lee, J.Y., Ramasamy, A.K., Ong, K.H., Verayiah, R., Mokhlis, H., Marsadek, M. (2023), Energy storage systems: A review of its progress and outlook, potential benefits, barriers and solutions within the Malaysian distribution network. *Journal of Energy Storage*, 72, 108360.
- Li, F., Yu, Y., Shu, Y., Liu, X. (2023), Study on characteristics of photovoltaic and photothermal coupling compressed air energy storage system. *Process Safety and Environmental Protection*, 178, 147-155.
- Liu, D., Zhao, F., Wang, S., Cui, Y., Shu, J. (2023), Optimal allocation method of energy storage for integrated renewable generation plants based on power market simulation. *Energy Storage and Saving*, 2(3), 540-547.
- Liu, W.H., Alwi, S.R.W., Hashim, H., Muis, Z.A., Klemeš, J.J., Rozali, N.E.M., Lim, J.S., Ho, W.S. (2017), Optimal design and sizing of integrated centralized and decentralized energy systems. *Energy Procedia*, 105, 3733-3740.
- Martins, A.A., Mota, M.G., Caetano, N.S., Mata, T.M. (2020), Decentralized electricity storage evaluation in the Portuguese context. *The Electricity Journal*, 33(8), 106822.
- McPherson, M., Stoll, B. (2020), Demand response for variable renewable energy integration: A proposed approach and its impacts. *Energy*, 197, 117205.
- Ministry of Economy. (2023a), Malaysia Energy Transition Roadmap. New Delhi: Ministry of Economy.
- Ministry of Economy. (2023b), National Energy Transition Roadmap: Energizing the Nation, Powering Our Future. Ministry of Economy. Available from: https://www.ekonomi.gov.my/sites/default/files/2023-09/national%20energy%20transition%20roadmap_0.pdf
- Motyka, M., Sanborn, S., Slaughter, A., Sharma, K., Vasantlal Shah, D. (2018), Supercharged: Challenges and Opportunities in Global Battery Storage Markets. India: Deloitte Center for Energy Solutions. Available from: <https://www2.deloitte.com/content/dam/deloitte/global/documents/energy-and-resources/gx-er-challenges-opportunities-global-battery-storage-markets.pdf> [Last accessed on 2024 Jul 28].
- Naval, N., Yusta, J.M., Sánchez, R., Sebastián, F. (2023), Optimal scheduling and management of pumped hydro storage integrated with grid-connected renewable power plants. *Journal of Energy Storage*, 73, 108993.
- Niu, J., Zhang, C., Li, Y., Wu, Y., Sun, H. (2024), Design and investigation of cold storage material for large-scale application in supercritical compressed air energy storage system. *Journal of Energy Storage*, 75, 109680.
- Ogunjuyigbe, A.S.O., Ayodele, T.R., Akinola, O.O. (2016), Impact of distributed generators on the power loss and voltage profile of sub-transmission network. *Journal of Electrical Systems and Information Technology*, 3(1), 94-107.
- Pelosi, D., Baldinelli, A., Cinti, G., Ciupageanu, D.A., Ottaviano, A., Santori, F., Carere, F., Barelli, L. (2023), Battery-hydrogen vs. flywheel-battery hybrid storage systems for renewable energy integration in mini-grid: A techno-economic comparison. *Journal of Energy Storage*, 63, 106968.
- Report on Peninsular Malaysia Generation Development Plan 2020 (2021-2039). (2021), Energy Commission. Available from: <https://e-aset.st.gov.my/my/web/download/listing/169> [Last accessed on 2024 Feb 28].
- Saha, S., Saini, G., Mishra, S., Chauhan, A., Upadhyay, S. (2022), A comprehensive review of techno-socio-enviro-economic parameters, storage technologies, sizing methods and control management for integrated renewable energy system. *Sustainable Energy Technologies and Assessments*, 54, 102849.
- Sakai, A. (2021), Designing a Grid-Connected Battery Energy Storage System: Case Study of Mongolia. Asian Development Bank: The Philippines. Available from: <https://policycommons.net/artifacts/3772465/designing-a-grid-connected-battery-energy-storage-system/4578138>
- SEDA. (2021a), Malaysia Renewable Energy Roadmap. SEDA Malaysia. Available from: <https://www.seda.gov.my/reportal/myrer>
- SEDA. (2021b), Malaysia Renewable Energy Roadmap: Pathway Towards Low Carbon Energy System. SEDA Malaysia. Available from: https://www.seda.gov.my/reportal/wp-content/uploads/2021/12/myrer_webver-1.pdf
- Stougie, L., Del Santo, G., Innocenti, G., Goosen, E., Vermaas, D., Kooi, H.V.D., Lombardi, L. (2019), Multi-dimensional life cycle assessment of decentralised energy storage systems. *Energy*, 182, 535-543.
- Suruhanjaya Tenaga. (2020), Peninsular Malaysia Generation Development Plan. Available from: <https://www.st.gov.my/eng/web/download/listing/169>
- Teo, Y.L., Go, Y.I. (2021), Techno-economic-environmental analysis of solar/hybrid/storage for vertical farming system: A case study, Malaysia. *Renewable Energy Focus*, 37, 50-67.
- Toloo, M., Taghizadeh-Yazdi, M., Mohammadi-Balani, A. (2022), Multi-objective centralization-decentralization trade-off analysis for multi-source renewable electricity generation expansion planning: A case study of Iran. *Computers and Industrial Engineering*, 164, 107870.

- Tong, W., Lu, Z., Hunt, J.D., Zhao, H., Han, M., Zhao, G. (2023), Energy management system for modular-gravity energy storage plant. *Journal of Energy Storage*, 74, 109283.
- Wali, S.B., Hannan, M.A., Ker, P.J., Rahman, S.A., Le, K.N., Begum, R.A., Tiong, S.K., Mahlia, T.M.I. (2024), Grid-connected lithium-ion battery energy storage system towards sustainable energy: A patent landscape analysis and technology updates. *Journal of Energy Storage*, 77, 109986.
- Xiao, J.W., Yang, Y.B., Cui, S., Liu, X.K. (2022), A new energy storage sharing framework with regard to both storage capacity and power capacity. *Applied Energy*, 307, 118171.
- Yang, Y., Wu, Z., Yao, J., Guo, T., Yang, F., Zhang, Z., Ren, J., Jiang, L., Li, B. (2024), An overview of application-oriented multifunctional large-scale stationary battery and hydrogen hybrid energy storage system. *Energy Reviews*, 3, 100068.
- Zhang, C., Yang, Y., Liu, X., Mao, M., Li, K., Li, Q., Zhang, G., Wang, C. (2023), Mobile energy storage technologies for boosting carbon neutrality. *The Innovation*, 4(6), 100518.