

# DIGITALES ARCHIV

ZBW – Leibniz-Informationszentrum Wirtschaft  
ZBW – Leibniz Information Centre for Economics

Surya, Batara; Syafri, Syafri; Thamrin, Rahmawati et al.

## Article

### Utilization of space based on renewable energy in the new city of Moncongloe-Pattalassang metropolitan Mamminasata, Indonesia

International Journal of Energy Economics and Policy

#### Provided in Cooperation with:

International Journal of Energy Economics and Policy (IJEEP)

*Reference:* Surya, Batara/Syafri, Syafri et. al. (2024). Utilization of space based on renewable energy in the new city of Moncongloe-Pattalassang metropolitan Mamminasata, Indonesia. In: International Journal of Energy Economics and Policy 14 (4), S. 234 - 250.  
<https://www.econjournals.com/index.php/ijEEP/article/download/14811/7984/37883>.  
doi:10.32479/ijEEP.14811.

This Version is available at:

<http://hdl.handle.net/11159/701067>

#### Kontakt/Contact

ZBW – Leibniz-Informationszentrum Wirtschaft/Leibniz Information Centre for Economics  
Düsternbrooker Weg 120  
24105 Kiel (Germany)  
E-Mail: [rights\[at\]zbw.eu](mailto:rights[at]zbw.eu)  
<https://www.zbw.eu/econis-archiv/>

#### Standard-Nutzungsbedingungen:

Dieses Dokument darf zu eigenen wissenschaftlichen Zwecken und zum Privatgebrauch gespeichert und kopiert werden. Sie dürfen dieses Dokument nicht für öffentliche oder kommerzielle Zwecke vervielfältigen, öffentlich ausstellen, aufführen, vertreiben oder anderweitig nutzen. Sofern für das Dokument eine Open-Content-Lizenz verwendet wurde, so gelten abweichend von diesen Nutzungsbedingungen die in der Lizenz gewährten Nutzungsrechte.

#### Terms of use:

*This document may be saved and copied for your personal and scholarly purposes. You are not to copy it for public or commercial purposes, to exhibit the document in public, to perform, distribute or otherwise use the document in public. If the document is made available under a Creative Commons Licence you may exercise further usage rights as specified in the licence.*



<https://zbw.eu/econis-archiv/termsfuse>



# Utilization of Space Based on Renewable Energy in the New City of Moncongloe-Pattalassang Metropolitan Mamminasata, Indonesia

Batara Surya<sup>1\*</sup>, Syafri Syafri<sup>2</sup>, Rahmawati Thamrin<sup>3</sup>, Syahrul Sariman<sup>4</sup>, Hernita Hernita<sup>5</sup>, Agus Salim<sup>6</sup>, Nasrullah Nasrullah<sup>7</sup>

<sup>1</sup>Department of Urban and Regional Planning, Faculty of Engineering, University Bosowa Makassar City, Indonesia, <sup>2</sup>Department of Urban and Regional Planning, Faculty of Engineering, University Bosowa Makassar City, Indonesia, <sup>3</sup>Department of Medicine, Faculty of Medicine, University Bosowa, Makassar City 90231, <sup>4</sup>Department of Civil Engineering, Faculty of Engineering, University Bosowa, Makassar City, Indonesia, <sup>5</sup>Department of Economic, STIM Lasharan Jaya, Makassar City 90231, Indonesia, <sup>6</sup>Department of Regional Planning, Faculty of Engineering, University Bosowa Makassar City, 90231 Indonesia, <sup>7</sup>Department of Architectural, Faculty of Engineering, University Bosowa, Makassar City 90231, Indonesia. \*Email: [batara.surya@universitasbosowa.ac.id](mailto:batara.surya@universitasbosowa.ac.id)

Received: 02 July 2023

Accepted: 27 April 2024

DOI: <https://doi.org/10.32479/ijeep.14811>

## ABSTRACT

Allocation of space in the development of new city areas for the needs of socio-economic activities contributes to the complexity of land use and environmental degradation. This study aims to: (1) Analyze the effect of space utilization allocation, activity systems, and population mobility on the increase in energy demand for the new city of Moncongloe-Pattalassang; (2) Analyze the direct and indirect effects of activity systems, changes in land use, allocation of space use, on the need for renewable energy, and improving the environmental quality of new city areas; and (3) Formulate a model of space utilization based on renewable energy and the sustainability of new city development. This study uses a qualitative and quantitative approach. Data obtained through observation, surveys, in-depth interviews, and documentation. The results of the study show that the allocation of space utilization coupled with the use of renewable energy contributes to improving the environmental quality of the new city of Moncongloe-Pattalassang. The allocation of space utilization, activity systems, and population mobility explains that 97.61% of the energy needs of the new city of Moncongloe-Pattalassang. Furthermore, the influence of the total activity system, changes in land use, and allocation of space use on renewable energy needs contributed 60.58% and the direct influence of renewable energy demand on improving the environmental quality of the new city of Moncongloe-Pattalassang was 67.73%. This study recommends the use of renewable energy to support social activity functions towards improving environmental quality and the sustainability of the development of the new city area Moncongloe-Pattalassang.

**Keywords:** Spatial Utilization, Environmental Quality, New City Areas, Sustainable Development

**JEL Classifications:** Q47, Q2, Q01

## 1. INTRODUCTION

The development of new cities developed in Indonesia is identified as having an impact on changes in land use, spatial use allocation, and infrastructure systems towards spatial integration of metropolitan cities (Surya et al., 2021; Alhazzani et al., 2021; Surya et al., 2022). The increase in population and changes in land

use are closely related to the conversion of productive agricultural land and its influence on the spatial dynamics of metropolitan cities (Surya et al., 2021). Thus, the allocation of new city space utilization has an impact on increasing infrastructure needs and energy needs (Atharinafi and Wijaya, 2021). Furthermore, the orientation of the development of new cities coupled with the utilization of renewable energy will be towards restoring

environmental quality and ecosystem balance towards the sustainability of metropolitan urban development (Surya et al., 2020). This means that the development of new cities is aimed at providing convenience in services and meeting energy needs in a sustainable manner (Surya et al., 2020; Lu et al., 2022).

The development of new city within the Mamminasata Metropolitan urban system was developed to support the fulfillment of infrastructure needs, socio-economic facilities, as well as housing and settlements (Teston et al., 2022; Surya et al., 2023). This means that new city are created to meet the needs of service facilities, management of development, and improvement of environmental quality in the direction of increasing the economic productivity of the community (Wang et al., 2020; Majeed et al., 2022). Furthermore, accuracy in allocating spatial use will ensure ecosystem stability and sustainable urban development (Wu et al., 2022; Kalfas et al., 2023). In order to support these efforts, four main principles need to be implemented as a unified system in the development of a new city, namely: (1) infrastructure network system improvement; (2) fulfillment of socio-economic facility services; (3) ease of mobility and movement of goods and services; and (4) increasing the productivity of community economic enterprises. These four things will be achieved if they are developed towards a balanced development by taking into account environmental, economic and social sustainability (Surya 2021; Bao and He, 2022; Tejada-Gutiérrez et al., 2023).

The construction of the new city Moncongloe-Pattalassang within the Mamminasata Metropolitan urban system was carried out to meet the demand for services due to an increase in population which tends to increase from time to time. The land used for the development of the new city covers an area of 3,825 ha. Furthermore, activities are developed, including: (a) housing and settlements utilizing an area of 4,145 ha, (b) a road network utilizing an area of 75 ha, (c) socio-economic facilities utilizing an area of 450 ha, (d) environmental parks and open land green utilizes an area of 112 ha, and (e) the availability of development areas utilizes an area of 1,284 ha. The concentration of socio-economic activities in big cities has an impact on the complexity of spatial use and the ineffectiveness of urban land use (Surya et al., 2020; Kisiała and Rączka, 2021; Abdulla and Ibrahim, 2023; Li and Zhao, 2023). Thus, the development of the new city of Moncongloe-Pattalassang will require support for the use of renewable energy that is integrated with the provision of facilities and infrastructure and other activities. Development activities will require support for the use of renewable energy towards improving environmental quality (Hanif et al., 2022; Gyimah et al., 2023; Yang et al., 2023).

Studies that support this research include: (1) Research conducted by Warrington and Layton (2023), stated that the use of renewable energy will ensure the achievement of ecosystem stability and reduction of emission gas pollution towards the sustainability of urban development; (2) Study Ortega-Gil et al. (2021), found that the use of renewable energy in urban development will prevent environmental degradation, restore cost efficiency, and overcome global environmental problems; and (3) Studies conducted by Lovering et al. (2022), found that the utilization of

renewable energy with a decarbonization scenario coupled with the replacement of fossil fuels with environmentally friendly fuels (green fuel) will ensure the stability of urban ecosystems and natural habitats. The three studies are more towards affirming that the use of renewable energy contributes to reducing gas emissions, ensuring ecosystem stability, and global environmental sustainability. Furthermore, this study is more focused on the allocation of new urban space utilization based on renewable energy utilization which will encourage environmental quality improvement, energy use efficiency, and ecosystem stability towards sustainable development. Thus, the use of renewable energy contributes to increasing economic productivity and creating stability in the built environment (Ait Sidhoum et al., 2022; Vo et al., 2022).

The long-term benefits obtained include: (1) Ensuring the environmental quality of the new city; (2) Fulfillment of energy needs to support the socio-economic activities of the community; and (3) The implementation of the governance of the development of a new city with an environmental perspective. These three principles will encourage the creation of an environmental balance towards the effective use of natural resources and the restoration of environmental quality (Chen et al., 2022; Wu et al., 2023). Thus, the use of renewable energy will ensure the continuity of energy needs for various socio-economic activities towards economic growth and sustainable urban development (Purnamawati et al., 2023; He and Wei, 2023).

The idea and concept of developing the new city of Moncongloe-Pattalassang is oriented towards supporting the activities of the Mamminasata Metropolitan urban system through the use of renewable energy. Furthermore, the potential energy that can be utilized to support the development of new cities, among others: (a) solar energy with a solar panel system to meet electricity needs for housing, socio-economic facilities, and street lighting; (b) water energy to meet the drinking water needs of the population; and (c) the results of domestic waste processing and socio-economic activities (compost) to meet the needs of environmental parks. The use of renewable energy will ensure stability and restoration of environmental quality. Thus, the urgency of this study is directed at four main interests, namely: (1) restoration and improvement of the environmental quality of the new city; (2) meeting the need for renewable energy through infrastructure support; (3) encouraging an increase in economic productivity; and (4) the creation of governance and sustainability of the development of the new city of Moncongloe-Pattalassang. Thus, the research questions that will be answered in this study are (1) How is the influence of space utilization allocation, activity systems, and population mobility on the increase in energy demand for the new city of Moncongloe-Pattalassang; (2) How big is the direct and indirect influence of the activity system, changes in land use, allocation of space use, to the need for renewable energy, and improving the environmental quality of new cities; and (3) How is the spatial utilization model based on the use of renewable energy and the sustainability of new city development. The conceptual framework built in this study is presented in Figure 1 below.

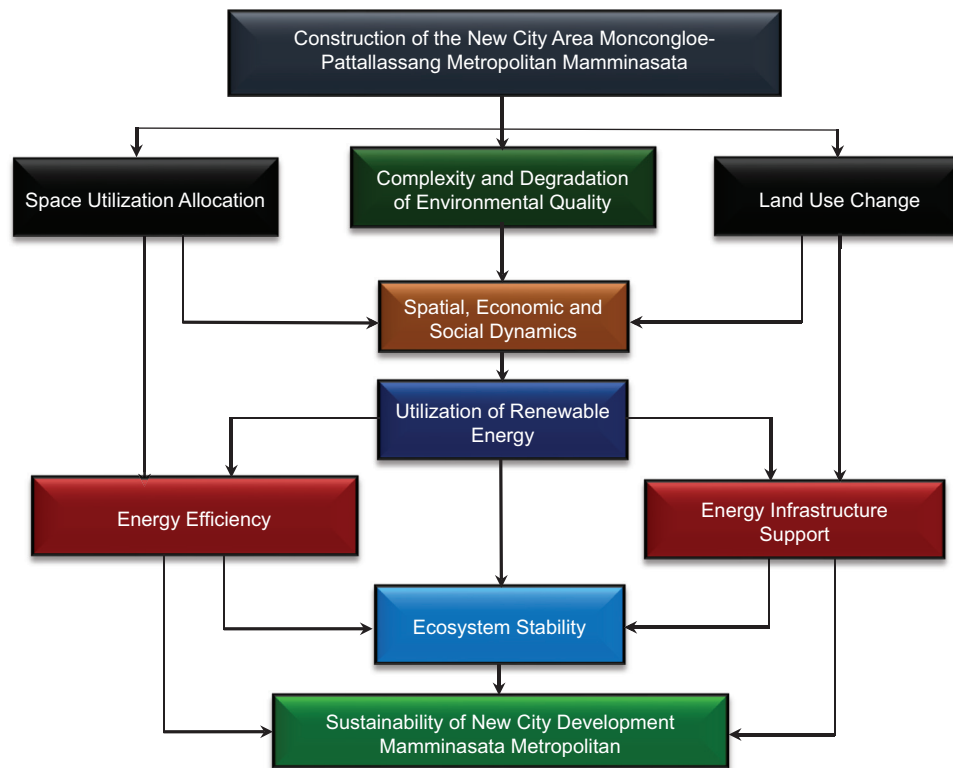
**Figure 1:** Conceptual framework for the development of the New City Moncongloe Pattalassang

Source: Author's elaboration

## 2. MATERIALS AND METHODS

This study uses a qualitative and quantitative approach. Quantitative data obtained through surveys and documentation. While qualitative data obtained through observation and in-depth interviews. Case studies were selected in this study with the following considerations: (1) the characteristics of the case for the new city of Moncongloe-Pattalassang are specific; (2) The reality that develops in the field is complex; (3) The allocation for new city development is characterized by the complexity of spatial use and contributes to the decline in environmental quality; and (4) A growing activity system will require support for the use of renewable energy. Furthermore, a combination of explanatory quantitative-qualitative approaches is presented in Figure 2.

### 2.1. Study Area

This study was carried out in the new city of Moncongloe-Pattalassang Metropolitan Mamminasata. The selection of the research location was based on the following considerations: (1) The new city of Moncongloe-Pattalassang is in a strategic location and functions to integrate the Mamminasata Metropolitan urban system; (2) The activity system developed has an impact on changes in land use; (3) The developed infrastructure system has an impact on the connectivity of the transportation network system and population mobility; (4) Allocation of developed spatial use affects the increase of community's economic productivity; and (5) The construction of the new city of Moncongloe-Pattalassang has an impact on increasing energy demand. Furthermore, the location of the study implementation is presented in Figure 3 below.

### 2.2. Method of Collecting Data

The grouping of data in the study is divided into two categories, namely: (1) Primary data, obtained through observation, surveys and in-depth interviews; and (2) secondary data, obtained through the results of studies related to the existence of the new city of Moncongloe-Pattalassang. Data collected through observation includes: (i) changes in land use, (ii) spatial use; and (iii) environmental characteristics of the new city. Furthermore, the instruments used in the observation were (i) field notes, (ii) periodical notes, and (iii) checklists. Data collected through surveys, among others: (a) the economic potential developed by the community, (b) types of facilities and infrastructure, (c) vehicle ownership, and (b) energy needs. Data collected through in-depth interviews, includes; (i) the socio-economic conditions of the community, (ii) the reasons for the community to use renewable energy, (iii) the stability of economic businesses, and (iv) the role of the community in utilizing renewable energy. The instruments used in the in-depth interviews were tape recorders and interview guides which were equipped with loose notes, data checklists, and rating scales.

The data collected through a questionnaire is assessed based on the following variables: (1) The community's economic potential is measured by indicators; type of business, scale of service, and type of energy used; (2) Types of facilities and infrastructure are measured by indicators; scale of infrastructure services, ratio of land use, area of land utilized, and availability of energy infrastructure; (3) Vehicle ownership is measured by indicators; choice of transportation mode, energy used, and availability of energy; (4) Energy demand is assessed by indicators; renewable

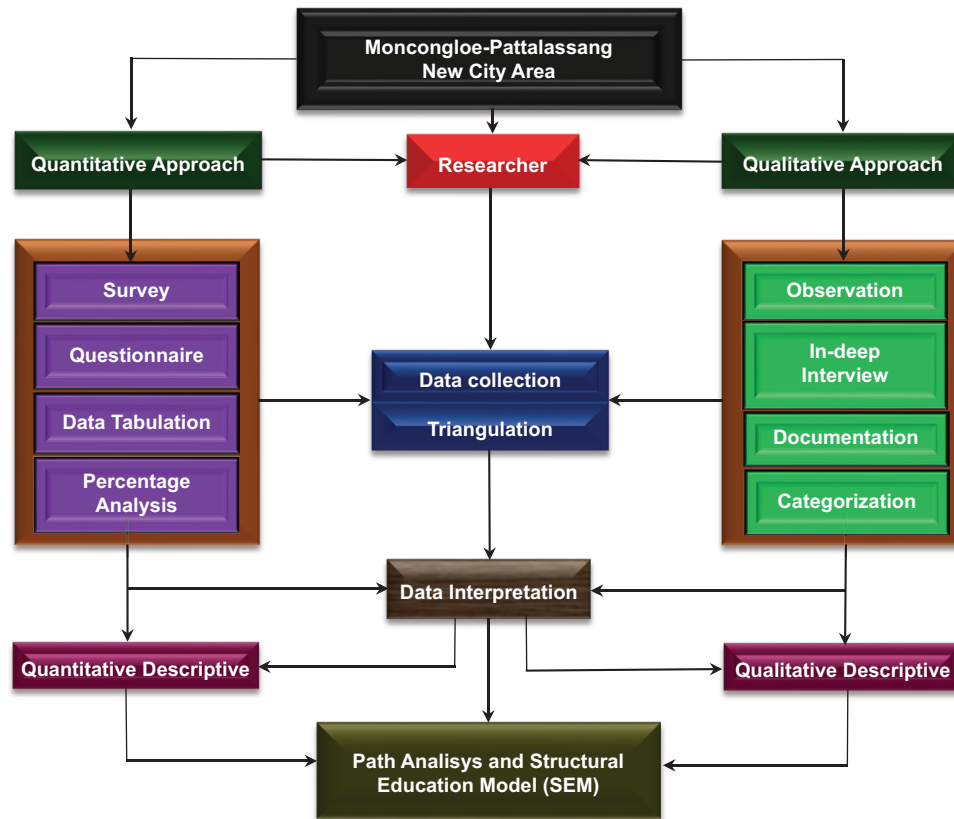
**Figure 2:** Combination of quantitative-qualitative approach

Source: Author's elaboration

energy potential, energy distribution, and availability of energy infrastructure; (5) Changes in land use are assessed by indicators; the area used, the characteristics of the land, and the type of activity built; System activity is measured by indicators; availability of social facilities, availability of economic facilities, and utilization of facilities; and (6) spatial utilization allocation is measured by indicators; spatial patterns, service systems, and infrastructure network systems. Data obtained through questionnaires were then measured using ordinal and ratio scales. Data measurement in this study uses scoring numbers, namely (i) a score of 5 for the very fulfilling category, (ii) 4 for the fulfilling category, (iii) 3 for the sufficiently fulfilling category, (iv) 2 for the less fulfilling category, and (v) a score 1 for the category not fulfilling. Furthermore, the documentation data used in this study include: (1) The master plan for the new city area of Moncongloe-Pattalassang was obtained through the Cipta Karya and Spatial Planning Office of the Province of South Sulawesi; (2) Data on the number of residents in new urban areas is obtained through the Central Bureau of Statistics, sub-district offices and sub-district offices; and (3) Policy data on the development of the new city area of Moncongloe-Pattalassang obtained through the Regional Development Planning Agency of South Sulawesi Province.

### 2.3. Research Informants and Respondents

The main source of qualitative data in this study is the informant. Furthermore, the snowball method is used to determine key informants who will be interviewed in depth. The main informant is considered to understand the initial process of implementing the construction of the new city of Moncongloe-Pattalassang.

Furthermore, the key informant was determined by the researcher to determine the next informant to be interviewed based on the required data. The use of the snowball method is used to obtain the same information related to the development of new cities to be associated with opportunities for utilizing renewable energy. In order to obtain more in-depth information in this study, several respondents were also selected as informants.

The number of informants in this study was determined as many as 14 people, 10 informants were determined based on information obtained from the developer and local government and 4 people from respondents. Four informants sourced from respondents were determined based on criteria; (1) The people living in the new town of Moncongloe-Pattalassang; (2) Economic actors who own businesses; (3) People who use private and public transportation modes; and (4) Local government involved in the management of the new city.

Questionnaire data in this study were obtained from respondents. Filling out the questionnaire was guided by researchers and enumerators. Questionnaires were distributed to the new city of Moncongloe-Pattalassang. The criteria for the actors who filled out the questionnaire were: (i) people who live in new cities, (ii) local government, (iii) people who have economic businesses, and (iv) people who use public transportation and private transportation. The enumerators in this study were selected with the following considerations: (1) Having skills in data collection; and (2) Understanding the socio-economic conditions of the community. Furthermore, the determination of the sample in the study was determined using a purposive sampling method which the

Figure 3: Research location for the new city of Moncongloe-Pattalassang

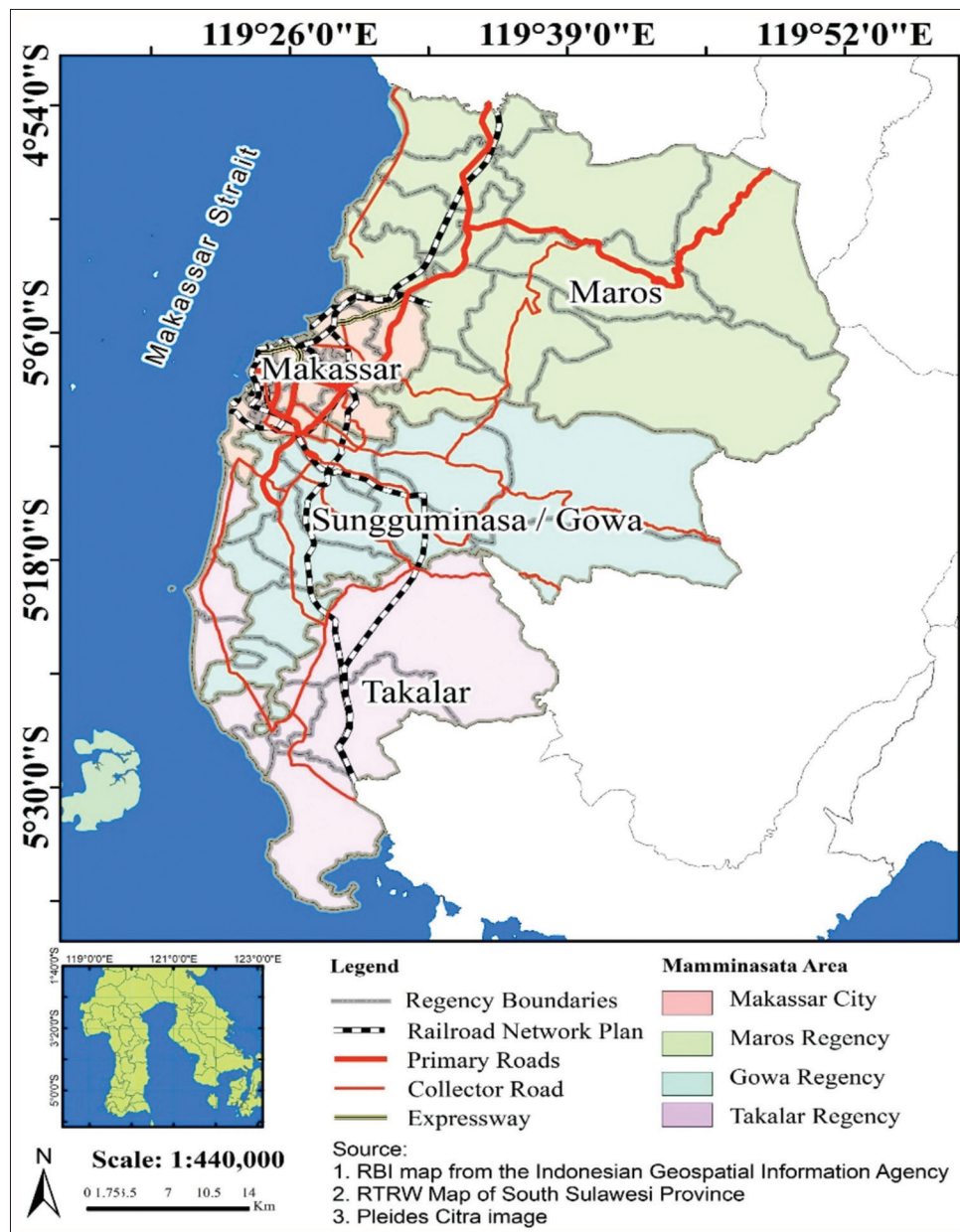

researcher determined with certain considerations. The sampling measurement technique refers to Cochran (1991). The formulation used in determining the number of samples, as follows:

$$n = \frac{Z^2 pq}{e^2}$$

where n is the number of samples required,  $Z^2$  is the value in the normal curve for a deviation of 5% with a value = 1.96, p represents a 50% probability of being correct (0.5), q represents a 50% probability of being wrong (0.5), and e is the level of sample error in the study using 5% of the 95% confidence level. Furthermore, the number of samples was set to 450 respondents.

#### 2.4. Data Analysis Method

Qualitative analysis in the study was examined based on data obtained through observation, in-depth interviews and

documentation. The analysis was carried out in three ways, namely data reduction, data presentation, and drawing conclusions. The results of the data analysis that has been carried out are then categorized by separating the information obtained based on the views of the informants and the facts found in the field. The stages of qualitative analysis in this study include: (1) Domain analysis, carried out by observing observed behavior based on; places, actors, and activities; (2) Taxonomic analysis, referring to the characteristics of the new city space utilization which is defined as a domain and then described in detail. This means that spatial use is studied in depth as a determining factor in meeting the renewable energy needs of new cities; (3) Component analysis is carried out by comparing the results of field findings which show that there are differences specifically based on the characteristics of the developing spatial use to be associated with energy needs; and (4) Analysis of cultural themes is used to integrate across domains found in the field. The aim is to explain

the determinants of renewable energy needs in the new city of Moncongloe-Pattalassang.

The multiple linear regression method was used to answer the question of space utilization allocation, activity systems, and population mobility as determining factors for the increase in energy demand for the new city of Moncongloe-Pattalassang. The assessed variable, namely  $X_1$  (space utilization),  $X_2$  (activity system),  $X_3$  (population mobility), and  $Y$  (energy needs). Test the correlation coefficient using the Pearson correlation coefficient. The category of data in this study is ordinal data, in the sense that the correlation between two or more variables is linear. Thus, the distribution of the data obtained shows a unidirectional relationship. Furthermore, path analysis is used to examine the direct and indirect effects of activity systems, changes in land use, allocation of space use, on renewable energy needs, and improving the environmental quality of new cities. Path analysis is tested based on variables, namely  $X_1$ , exogenous independent variable (activity system),  $X_2$ , exogenous independent variable (land use change),  $X_3$ , exogenous independent variable (allocation of space utilization),  $Y$ , endogenous dependent variable (renewable energy needs), and  $Z$ , endogenous dependent variable (improvement of environmental quality). Effect of variables using multiple linear regression methods, correlation, and path analysis. The analysis formulation used refers to the following equation:

$$Y = \beta_0 + \beta_1 X_1 + \beta_2 X_2 + \beta_3 X_3 + \beta_k X_k + \epsilon$$

$$r_{xy} = \frac{\sum_{x,y}}{\sqrt{(\sum x^2)(\sum y^2)}}$$

$$Y = \beta_1 X_1 + \beta_2 X_2 + \beta_3 X_3 + \epsilon$$

$Y$  is the dependent variable,  $X_1, X_2, X_3 \dots X_n$  are independent variables,  $\epsilon$  is the random residue,  $\beta_0, \beta_1, \beta_2, \beta_3, \dots \beta_k$  are population parameters whose values are not known and must be estimated from the data. The value of  $\beta_1$  expresses the contribution of the independent variable  $X_1$  to the dependent variable  $Y$ .  $r_{xy}$  is the correlation coefficient between variables  $X$  and  $Y$ ,  $r_{xy}$  is the correlation coefficient between variables  $X$  and  $Y$ , it can be estimated from the data. The value of  $\beta_1$  expresses the contribution of the independent variable  $X_1$  to the dependent variable  $Y$ .  $\sum_{x,y}$  is the product of  $X$  and  $Y$  values,  $\sum x^2$  is the square of the values of  $x$ ,  $\sum y^2$  is the square of the  $y$  value. Path analysis was used with consideration of (1) interval-scale research metric data, (2) the endogenous and endogenous dependent variables for the multiple regression models, the intermediate variables for mediation models, and the combined mediation and multiple regression models and complex models, (3) the pattern in the relationship between variables occurring in only one direction, and (4) causal relationships based on activity systems, changes in land use, allocation of space use to renewable energy needs and improvement of environmental quality. The application of the multiple regression and path analyses is shown in Figure 4.

Figure 4 shows the multiple linear regression analysis, with explanation  $Y$  as the dependent variable,  $X_1$  and  $X_2$  as independent variables,  $r_{12}$  as the relationship between  $X_1$  and  $X_2$ ,  $r_{1Y}$  and  $r_{2Y}$  as

the correlation values between variables  $X$  and  $Y$ , and  $t_{1Y}$  and  $t_{2Y}$  as significance values. In the path analysis model, several things can be explained: (1) The magnitude of the relationship is expressed by the correlation coefficient ( $r_{12}$ ), ( $r_{13}$ ), and ( $r_{23}$ ). ( $r_{12}$ ) shows the correlation or relationship between  $X_1$  and  $X_2$ , ( $r_{13}$ ) shows the correlation or relationship between  $X_1$  and  $X_3$ , and ( $r_{23}$ ) shows the correlation or relationship between  $X_2$  and  $X_3$ . (2) The variables  $X_1, X_2,$  and  $X_3$  act as independent variables affecting the dependent variable ( $y$ ). (3) The independent variable  $X_1$  and the dependent variable  $Y$  are connected by the regression coefficient ( $p_1$ ). (4) The independent variable  $X_2$  and the dependent variable  $Y$  are connected by the regression coefficient ( $p_2$ ). (5) The independent variable  $X_3$  and the dependent variable  $Y$  are connected by the regression coefficient ( $p_3$ ). (6) The magnitude of the direct effect of  $X_1$  on  $Y$  is the square of the regression coefficient ( $p_{12}$ ), the direct effect of  $X_2$  on  $Y$  is the square of the regression coefficient ( $p_{22}$ ), and the direct effect of  $X_3$  on  $Y$  is the square of the regression coefficient ( $p_{32}$ ). (7) The magnitude of the total influence is the coefficient of determination with the  $R^2$  symbol, which is the value of the total effect of the influence of the independent variables under study on the dependent variable: (i)  $R^2$  is the total effect, i.e. the direct effect + the indirect effect, (ii) ( $p_{12} + p_{22} + p_{32}$ ) is the direct effect of  $X_1, X_2,$  and  $X_3$  on  $Y$ , (iii) ( $p_1, r_{12}, p_2$ ) is the effect indirect variable  $X_1$  through  $X_2$  on  $Y$ , (iv) ( $p_2, r_{12}, p_1$ ) is the indirect effect of variables  $X_2$  through  $X_1$  on  $Y$ , (v) ( $p_1, r_{13}, p_3$ ) is the indirect effect of  $X_1$  through  $X_3$  on  $Y$ , (vi) ( $p_3, r_{13}, p_1$ ) is the indirect effect of variables  $X_3$  through  $X_1$  on  $Y$ , (vii) ( $p_2, r_{23}, p_3$ ) is the indirect effect of variables  $X_2$  through  $X_3$  on  $Y$ , and (viii) ( $p_3, r_{23}, p_2$ ) is the indirect effect of variables  $X_3$  through  $X_2$  on  $Y$ . (8) Meanwhile, epsilon ( $\epsilon$ ) expresses the amount of residual effect (residue), i.e. the magnitude of the influence of the independent variables that are not examined.

The structural equation model (SEM) in this study is used to build a spatial use model based on the use of renewable energy and the sustainability of the development of new urban areas, with the variables assessed, namely: (1) Exogenous variable constructs with indicators of allocation of space use ( $X_1$ ) with sub-indicators namely settlements, trade, public facilities, social facilities, and infrastructure; (2) Exogenous variable construct of renewable energy utilization ( $X_2$ ) measured by indicators, namely energy availability, energy distribution, and energy demand. (3) The construct of the exogenous variable that is assessed is the quality of the environment ( $X_3$ ), measured by indicators, namely pollution loads, changes in land cover, and the ratio of space utilization to the availability of green open space. Furthermore, the endogenous latent variables are: (i) restoration of environmental quality ( $y_1$ ) with sub-indicators of land use, air quality and water quality; (ii) environmental resilience latent variable ( $y_2$ ) measured by indicators of air pollution, water pollution, and soil pollution; (iii) sustainability of new city development ( $y_3$ ) with the sub-indicators being assessed, namely economic sustainability, environmental sustainability, and social sustainability. The SEM analysis method uses the following formulation:

$$\eta = \alpha + B_{\eta} \Gamma \xi + \zeta$$

$$\eta - B_{\eta} \Gamma \xi = \alpha + \zeta$$

$$(I - B_{\eta} \Gamma) \eta = \alpha + \zeta$$

$$\eta = (I - B_{\eta} \Gamma)^{-1} \alpha + \Gamma \xi + \zeta$$

Figure 4: Model of multiple regression analysis and path analysis

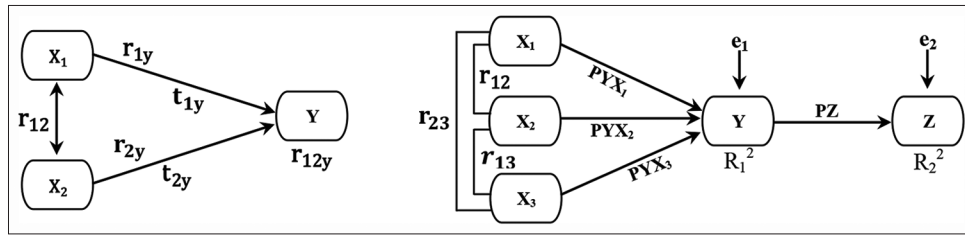

Where  $\alpha$  is the intercept vector, B and  $\Gamma$  is the coefficient matrix and  $\zeta = \zeta_1 \zeta_2 \dots \zeta_m$  is the error vector in the structural equation, element B presents variable influence  $\eta$  and variable  $\eta$  other, and elements  $\Gamma$  present a direct influence of variables  $\xi$  in variable  $\eta$ . It is assumed that  $\xi$  not correlated with  $\zeta$  and  $I - B$  is nonsingular. Furthermore, is the intercept vector  $m \times 1$ ,  $\eta$  is the endogenous latent variable  $m \times 1$ , B is the coefficient matrix of the endogenous latent variable  $m \times m$ ,  $\Gamma$  is the coefficient matrix of the exogenous latent variable  $m \times n$ ,  $\xi$  is the exogenous latent variable vector  $n \times 1$ ,  $\zeta$  structural model error vector relationship between  $\eta$  and  $\xi$  size  $m \times 1$ . Furthermore, random vector  $\eta$  and  $\xi$  not measured directly but through the indicator, namely the variable  $Y^T = (y_1, y_2, \dots, y_p)$  and  $X^T = (X_1, X_2, \dots, X_p)$ . The measurement model uses the following formulation:

$$df = \frac{p + q + 1}{2} = t$$

$$RMSEA = \frac{F_0}{df} \text{ or } F_0 = \max F = \frac{df}{n - 1}$$

$$AGFI = 1 - \frac{df_0}{df_n} = 1 - GFI$$

$$GFI = 1 - \frac{FS \sum \theta}{FS \sum \theta}$$

Where  $df_0$  is the degrees of freedom When there is a hypothesized model,  $df_n$  is the degrees of freedom for the hypothesized model.  $FS \sum \theta$  is the minimum value of the function F for the hypothesized model,  $FS \sum \theta$  is the minimum value of the function F when no model is hypothesized. GFI values are in the range from 0 to 1, and higher values are categorized as better. Furthermore, the Root Mean Square Error of Approximation (RMSEA) is the degree of fit used to measure the proximity of a model to the population. Then, AGFI is an extension of GFI which is used to compare the proposed model with the basic model. If the RMSEA value is  $\geq 0.05$  then the model is appropriate, and if the AGFI value ranges from 0 to 1 and the  $AGFI \geq 0.90$  shows good fit while  $0.80 \leq AGFI < 0.90$  showing marginal fit.

### 3. RESULTS AND DISCUSSION

#### 3.1. Allocation of Space Utilization and Energy Demand Determinants

Allocation of space utilization for the new city of Moncongloe-Pattalassang contributes to the increase in energy demand and its impact on environmental quality degradation. The use of renewable energy and environmental balance will be created if

followed by the implementation of sustainable development from the government (Qi et al., 2022; Khalil et al., 2022). The increase in energy demand is closely related to socio-economic activities and a transportation system that develops based on the pattern of origin and destination of travel. This means that the development of social and economic activities contributes to an increase in energy consumption (Wu and Lin, 2022). The trend of energy use based on the allocation of space utilization for the new city of Moncongloe-Pattalassang is presented in Figure 5 below.

Allocation of space use and energy use (Figure 5), shows three categories of types of energy used by the community in supporting socio-economic activities in the new city of Moncongloe-Pattalassang. Interpretations that can be proposed regarding the use of energy include: (1) The highest energy consumption is dominant in housing and settlement activities, namely fuel oil by 83.90%, electricity by 61%, and clean water 90.36%; (2) The use of fossil energy which continues to increase contributes positively to the environmental quality degradation of the new city of Moncongloe-Pattalassang; and (3) The increase in socio-economic activity is closely related to the increase in population in line with the increase in the need for housing and settlements and the impact on changes in land use towards the complexity of the utilization of new urban spaces. These results illustrate that dependence on the use of fossil energy which is quite high is positively associated with a decrease in environmental quality. Thus, dependence on fossil energy and increased commercial activity contribute to pollution and environmental degradation (Yao et al., 2020; Surya et al., 2021). Facts found in the field show that energy needs which have increased from time to time have an impact on depleting resource reserves, global warming, acid rain, climate change, ecosystem damage, and increasing oil prices. Furthermore, the dominant socio-economic activity using fossil energy has a positive contribution to increasing carbon dioxide pollution, ( $CO_2$ ), nitrous oxide ( $NO_2$ ), and sulfur dioxide ( $SO_2$ ) towards increasing air pollution, acid rain, and global warming. Thus, it can be concluded that the decline in the environmental quality of the new city of Moncongloe-Pattalassang is closely related to the increase in environmental pollution, namely soil, water, air, and ecosystem instability. Government policy support is needed to utilize and use renewable energy towards restoring environmental quality and sustainable development (Sharma et al., 2021; Tagwi 2022). Furthermore, sources of pollution and environmental degradation in new cities are presented in Figure 6 below.

Figure 6 shows the types of activities and sources of pollution in the new city of Moncongloe-Pattalassang. Interpretations that can be



proposed include: (1) The highest source of pollution is contributed by residential waste by 10.34% and vehicle exhaust by 10.81%; (2) Environmental media affected, namely soil, water and air; (3) Increasing socio-economic activities are positively associated with a decrease in environmental quality. Field facts found illustrate that the complexity of the use of new urban space, apart from having an impact on changes in land cover, also contributes to the balance of ecosystems, threats to public health, decreases aesthetic value, economic losses, and disruption of environmental systems. Increasing human activity causes the natural environment to be threatened, loss of habitat and biodiversity as well as its impact on ecosystem stability and public health (Adla et al., 2022; Rai et al., 2023). Thus, it can be concluded that the increase in development activities and the less optimal control of spatial use

have a positive contribution to the environmental balance of the new city. This means that setting pollution thresholds based on ecological characteristics is an important element that must be stipulated in the formulation of government policies (Yasir et al., 2023; Xiao et al., 2023). Efforts that can be made to reduce the pollution load are optimizing environmental management based on community participation and support for the commitment of all stakeholders to take real action towards saving the environment (Surya et al., 2020; Caperon et al., 2022). Furthermore, the use of fossil energy based on the means of transportation used in relation to community mobility is presented in Figure 7 below.

**Figure 5:** Allocation of space utilization and energy use for the new city of Moncongloe-Pattalassang

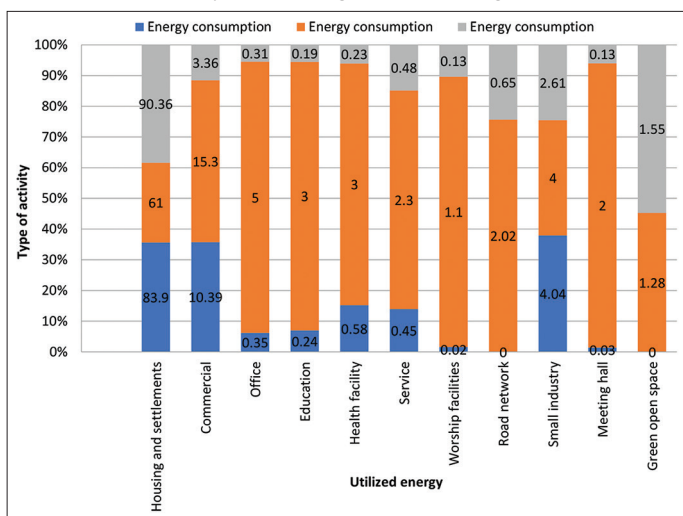

Source: Primary data

The use of fossil energy based on the mode of transportation used (Figure 7), shows that the daily traffic volume based on the origin and destination of movement tends to increase over time. Interpretations that can be proposed based on the field facts found include: (1) motorcycles and private cars are the dominant means of transportation used by the community based on the origin and destination of the trip; (2) diesel fuel and gasoline which are dominantly used by the public for the benefit of going to activity centers; and (3) the dominant use of fossil energy based on the choice of mode of transportation used has a positive contribution to air quality pollution. These results illustrate that the increase in the number of motorized vehicles coupled with the high use of fossil energy, in addition to increasing pollution, also affects the condition of public health. The government’s environmental management policy is an important element in reducing the pollution load and air pollution emissions produced by motorized vehicles (Surya et al., 2020; Abed Al Ahad et al., 2022). The facts found in the field illustrate that the high volume of traffic based on the origin and destination of trips is strongly influenced by the existence of a new city that is easily accessible and is located on the main urban road corridor of the Metropolitan Mamminasata. This means that the dynamics of the city which is quite high in line

**Figure 6:** Types of activities and sources of environmental pollution in the new city of Moncongloe-Pattalassang.

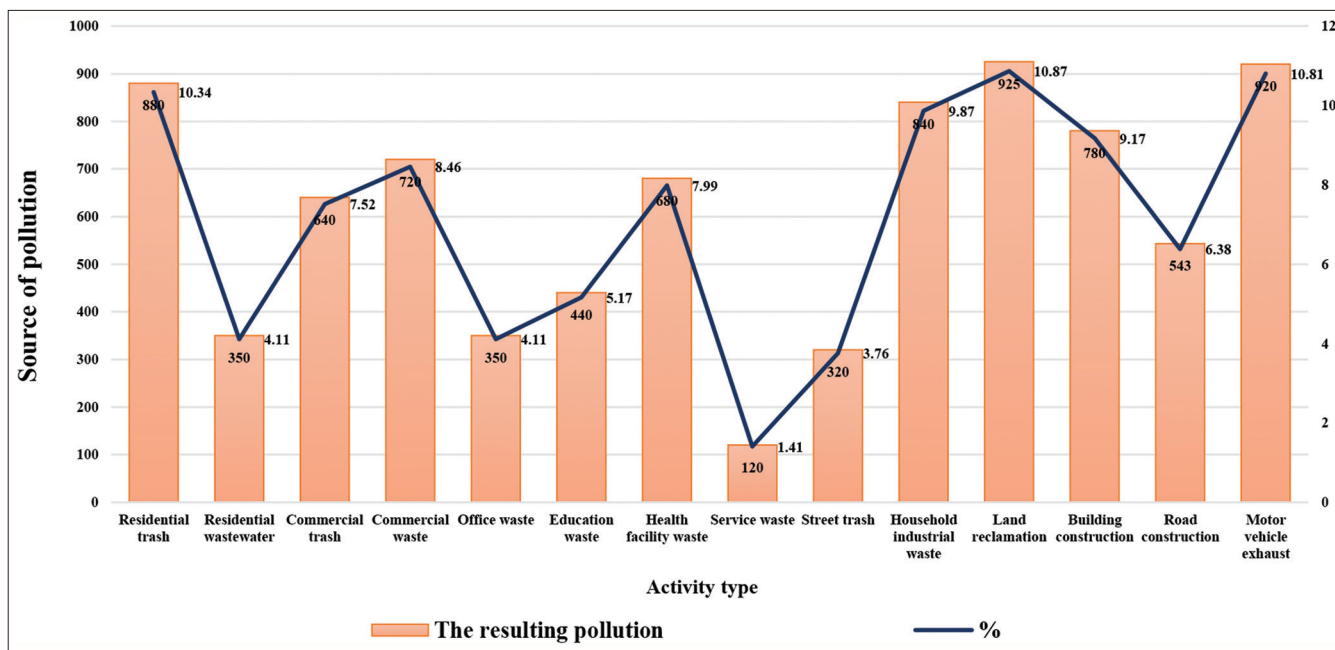

Source: Primary data

with the increase in population will affect the urban transportation system and the choice of modes of transportation used for travel purposes to the centers of activity (Gao et al., 2019; Mwale et al., 2022). Furthermore, the potential for renewable energy to be utilized in supporting the development of social, economic and transportation system activities is presented in Figure 8 below.

Figure 8 shows the renewable energy potential that can be used to support the socio-economic activities of the new city of Moncongloe-Pattalassang. Interpretations that can be proposed for these results include: (1) Renewable energy that is dominantly used, namely the use of hydropower to meet the need for clean water and to meet the need for electrical energy; (2) Renewable energy whose reserves are large enough to be used, namely solar and wind power; and (3) The potential of biomass energy has the opportunity to optimize its utilization to support the production process of economic activities. This means that the development of bioenergy is oriented towards producing wood pellets, biodiesel, biokerosene, bioethanol and biomethanol. Thus, utilization of renewable energy will reduce the impact of CO<sub>2</sub> emissions originating from fossil fuels and is beneficial for tackling climate change (Rashedi et al., 2022; Cavelius et al., 2023). Thus, it can

be concluded that the potential for renewable energy has the opportunity to be utilized in supporting the development of new cities in the future through the preparation of energy infrastructure that is placed in strategic locations. Furthermore, the effect of space utilization allocation, activity systems, and population mobility on the increase in energy demand for the new city of Moncongloe-Pattalassang, is presented in Table 1 below.

The results of Table 1 which can be explained include: (1) Allocation of space utilization has a positive effect on energy demand; (2) the activity system has a positive effect on energy needs; and (3) Population mobility has a positive effect on energy demand. Thus, it can be concluded that the allocation of space utilization, activity systems, and population mobility explains that 97.61% of the energy needs of the new city of Moncongloe-Pattalassang. This means that the use of renewable energy is very important and strategic in supporting the fulfillment of energy needs, both for socio-economic facilities and transportation movement systems that will be developed in the future.

### 3.2. New City Environmental Quality Improvement

Improving the environmental quality of the new city of Moncongloe-Pattalassang is basically carried out to ensure ecosystem stability towards increasing productivity and creating a harmonious and sustainable community life. Utilization of renewable energy in addition to ensuring the sustainability of the ecosystem also has an impact on the sustainability of human life (Strielkowski et al., 2021; Li et al., 2023). Furthermore, the new city activity system that is developing is marked by the existence of socio-economic facilities whose locations are in strategic positions and easily accessible by the community. This means that the right pattern of land use will have an impact on people's lives and support population mobility towards sustainable urban development (Kariuki et al., 2021; Kalfas et al., 2023). Respondents' perceptions of the socio-economic facility service system are presented in Figure 9 below.

**Figure 7:** Population mobility based on travel origin and destination patterns.

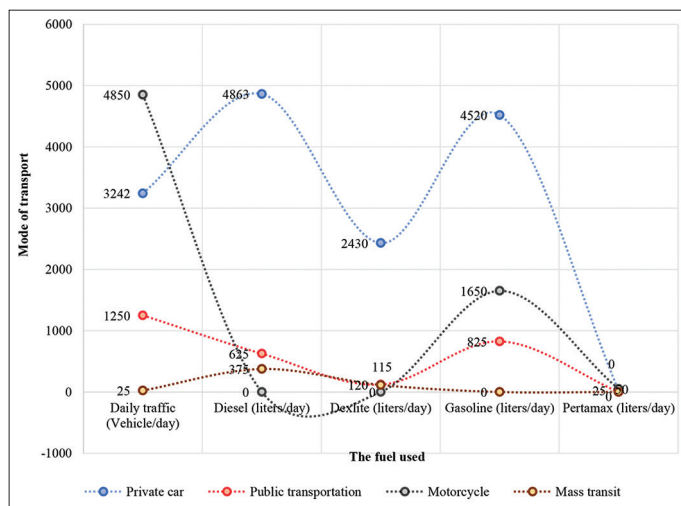

Source: Primary data

**Figure 8:** The potential for renewable energy in the new city of Moncongloe-Pattalassang.

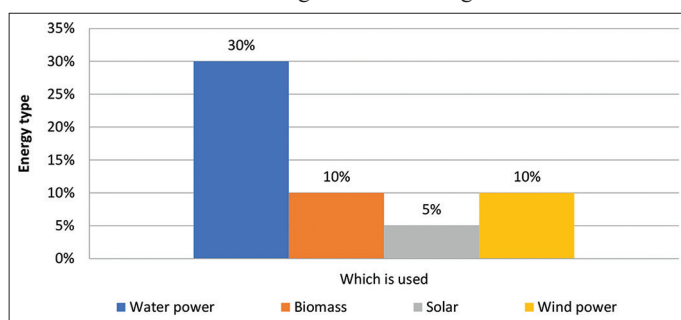

Source: Processed secondary data

Figure 9 which can be explained, among others: (1) 51.33% of respondents said that the availability of social facilities fulfilling, 14.89% said they enough fulfilling, and 33.78% not fulfilling; (2) 51.78% of respondents mentioned the availability of economic facilities in the fulfilling category, 12.89% said they enough fulfilling, and 35.33% not fulfilling; and (3) 44.22% of respondents said that the utilization of socio-economic facilities fulfilling, 16.89% enough fulfilling, and 38.89% not fulfilling. These results confirm that the availability of socio-economic facilities in terms of location and service radius has met the community's expectations. Thus, efforts are needed to optimize the use of socio-economic facilities that have been built to be integrated with environmental management systems (Shabani and Jerie, 2023). Furthermore, changes in land use for new cities are marked by the conversion of productive agricultural land and reduction of land cover. Changes in land use for the new city of Moncongloe-Pattalassang are presented in Figure 10 below.

Figure 10 shows respondents' perceptions of changes in land use for the new city of Moncongloe-Pattalassang. Interpretations that can be submitted to these results include: (1) Development

**Table 1: Summary of test results for the significance of multiple regression coefficients**

Correlation	Coefficient		Error	t-count	t-table
	$\beta$		$S_{bi}$		
Allocation of space utilization to energy needs ( $ryx_1$ )	0.192		0.068	2.873	1.95
System activity to energy needs ( $ryx_2$ )	0.139		0.054	2.855	1.95
Population mobility to energy needs ( $ryx_3$ )	0.407		0.096	4.185	1.95
Source variant	Sum of squares (JK)	Free Degrees (db)	Average of the sum of the squares (RJK)	F-count	F-table $\alpha=0.05$
Regression	20,643	3	6,548	86.815	4,78
Residue	0,459	6	0.077		
Total	20,643	9	-	-	-
R	R <sup>2</sup>	db1	db2	F-count	F-table
0.988	0.9761	3	6	86.815	4,78

**Figure 9:** The service system for socio-economic facilities for the new city of Moncongloe-Pattalassang

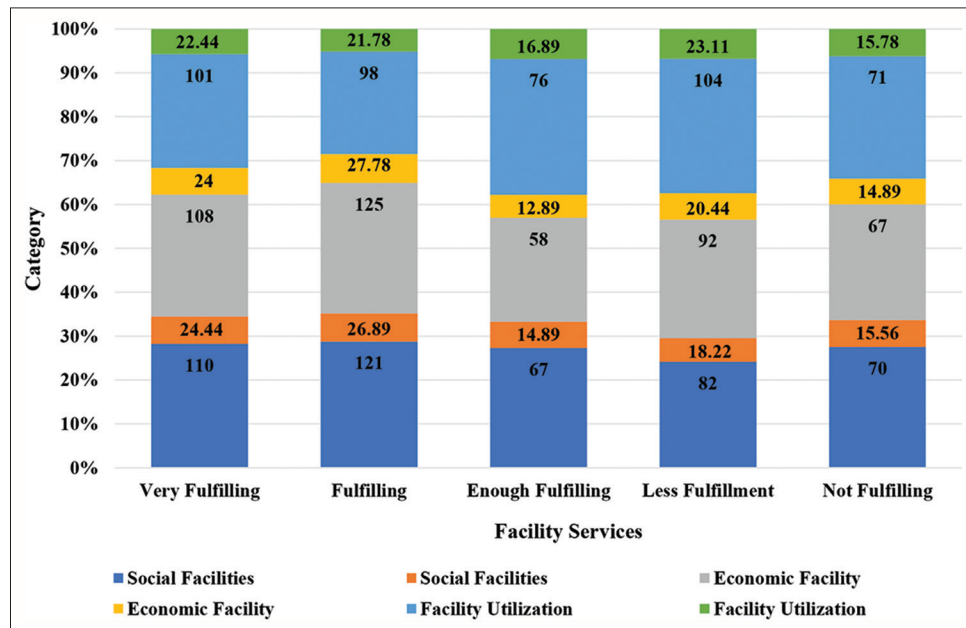

Source: Primary data

**Figure 10:** Changes in land use for the new city of Moncongloe-Pattalassang

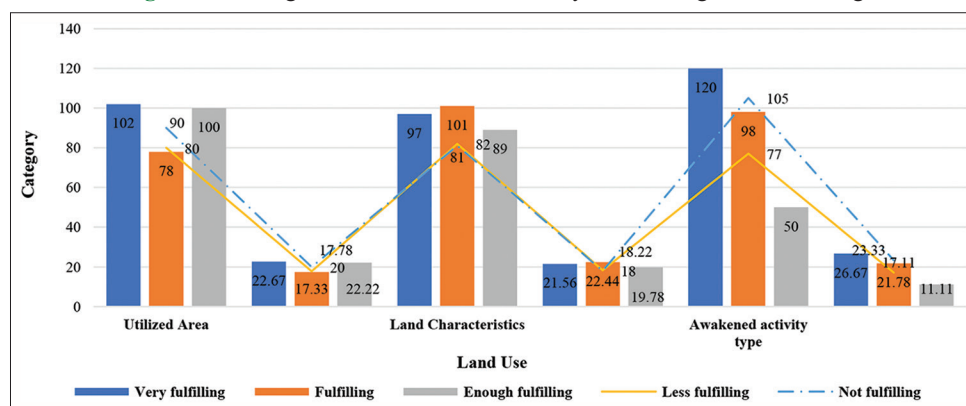

Source: Primary data

of socio-economic activities that occupy strategic locations by 40% fulfilling, 22.22% enough fulfilling, and 37.78% not fulfilling; (2) In terms of physical land characteristics, 44% fulfilling, 19.78% enough fulfilling, and 36.22% not fulfilling; (3) Types of activities built based on the scale of service show that 48.45% fulfilling, 11.11% enough fulfilling, and 40.44%

not fulfilling. These results illustrate that the trend of land use change which continues to increase from time to time is positively associated with a decrease in environmental quality. Changes in land use have an impact on resource depletion and environmental degradation (Wang et al., 2023). Thus, it is necessary to control the use of space that is integrated with

environmental management. Allocation of new city space utilization is presented in Figure 11 below.

Interpretations of Figure 11 that can be submitted include: (1) Respondents' perceptions regarding the allocation of spatial use in relation to the spatial pattern built gives an overview of 42.67% fulfilling, 17.78% fulfilling, and 39.55% not fulfilling; (2) The activity service system shows that 38% fulfilling, 21.78% enough fulfilling, and 40.22% not fulfilling; and (3) the infrastructure network system shows that 32.44% fulfilling, 24% enough fulfilling, and 43.56% not fulfilling. These results illustrate the allocation of spatial use which is dominated by the existence of housing, socio-economic facility services

and infrastructure network systems that contribute positively to environmental degradation, changes in land cover, and conversion of productive agricultural land towards ecosystem instability. Thus, efforts are needed to optimize the utilization of natural resources, environmental sustainability, and restoration of environmental quality based on the role of community participation. Furthermore, the availability of facilities and infrastructure for the new city of Moncongloe-Pattalassang is presented in Figure 12 below.

Figure 12 which can be explained, among others: (1) Availability of facilities and infrastructure in relation to infrastructure services shows that 30.67% fulfilling, 26.66% enough fulfilling, and 42.67% not fulfilling; (2) The ratio of land use used shows that 43.56%

**Figure 11:** Allocation of space utilization for the new city of Moncongloe-Pattalassang

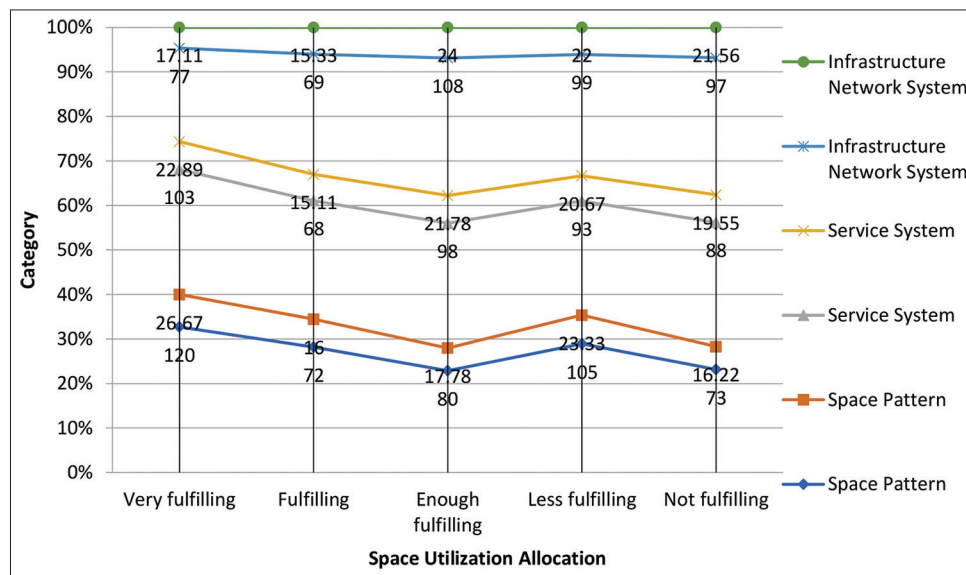

Source: Primary data

**Figure 12:** Availability of facilities and infrastructure for the new city of Moncongloe-Pattalassang

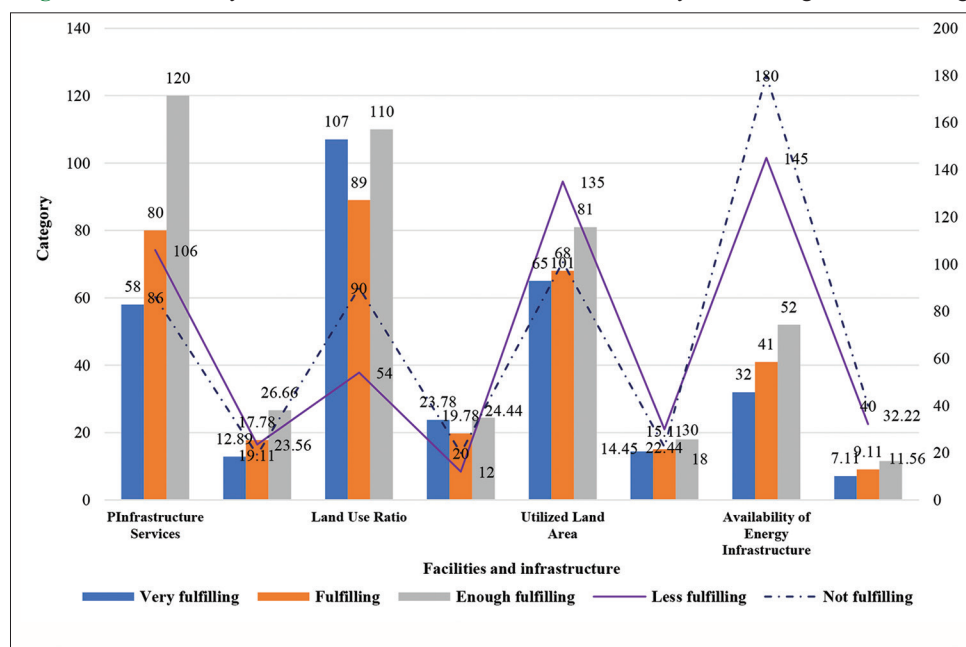

Source: Primary data

fulfilling, 24.44% enough fulfilling, and 32% not fulfilling; and (3) the availability of energy infrastructure obtained an overview of 16.22 fulfilling, 11.56% enough fulfilling, and 72.22 not fulfilling. These results illustrate that optimizing the use of facilities and infrastructure still requires the availability of energy infrastructure to support movement systems and community travel destinations in relation to the use of renewable energy. Furthermore, vehicle ownership and modes of transportation used to go to activity centers based on travel destinations are presented in Figure 13 below.

Figure 13 which can be explained, among others: (1) Private car ownership is the choice of mode of transportation used by 48.67% for the fulfilling category, 23.33% enough fulfilling, and 28% not fulfilling; (2) The energy used shows 34.66% for the fulfilling category, 21.56 is enough fulfilling, and 43.78% not fulfilling; (3) The availability of energy shows 30% for the fulfilling category, 24.89% enough fulfilling, and 45.11 not fulfilling. These results confirm that the use of renewable energy in relation to the choice of transportation mode used by the community is not optimal. Thus, efforts are needed to optimize the management and utilization of renewable energy in order to reduce the burden of environmental pollution. This means that policy support from the government

is an important element in environmental management and pollution control towards improving people’s quality of life in a sustainable manner (Marcantonio et al., 2021; Mustafa et al., 2023). Furthermore, the energy needs of the new Moncongloe-Pattalassang city are presented in Figure 14 below.

Figure 14 which can be explained, among others: (1) Respondents’ perceptions of renewable energy potential that can be used shows 62.22% in the fulfilling category, 22% enough fulfilling, and 15.78% not fulfilling; (2) The distribution of renewable energy to support community activities shows that 24.44% fulfilling category, 14.90% enough fulfilling, and 60.66% not fulfilling; and (3) Support for the availability of energy infrastructure shows that 11.33% fulfilling category, 13.11% enough fulfilling, and 75.56% not fulfilling. These results confirm that maximum effort is needed from the government and the private sector to prepare energy infrastructure support whose space allocation is placed in a strategic location to facilitate public access to the required renewable energy services. The impact of using renewable energy is to encourage increased economic performance and support the achievement of development, ease of service, and fulfillment of energy needs for the community (Oskouei et al., 2022; Sim, 2023). Furthermore, the direct and indirect effects of activity

**Figure 13:** Vehicle ownership and mobility of residents of the new city of Moncongloe-Pattalassang

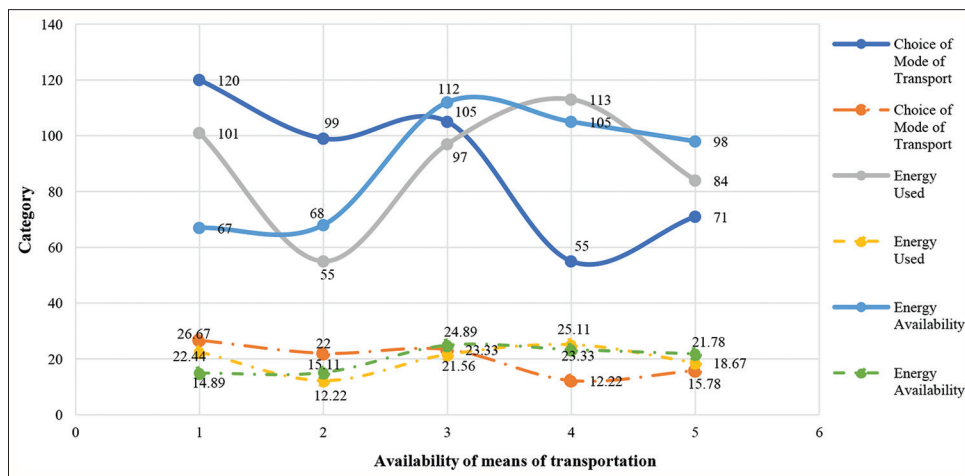

Source: Primary data

**Figure 14:** Meeting of the needs of renewable energy for the new city of Moncongloe-Pattalassang

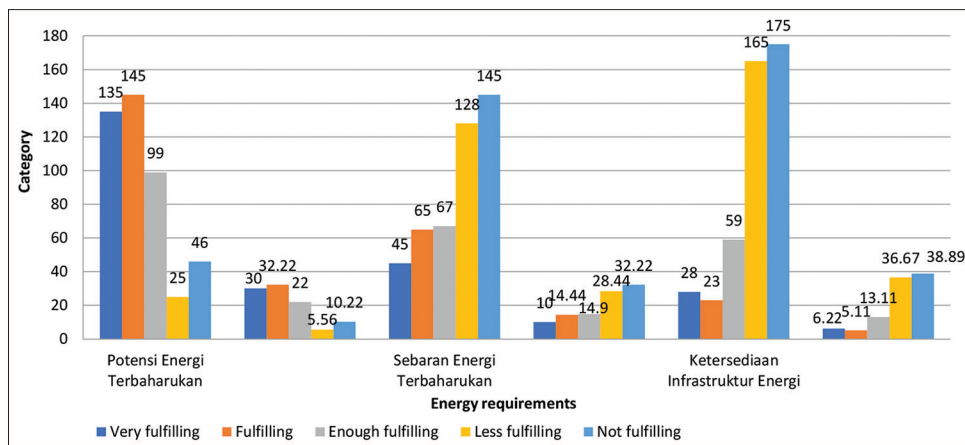

Source: Primary data

systems, changes in land use, allocation of space use, on renewable energy needs, and improving the environmental quality of the new city of Moncongloe-Pattalassang are presented in Figure 15 below.

Figure 15 which can be explained: (1) The relationship or correlation between the activity system variables and the land use change variable is 0.623; (2) The relationship or correlation between the activity system variables and the space utilization allocation variable is 0.342; and (3) The relationship or correlation between the variables of land use change and the spatial use allocation variable is 0.567. Furthermore, the direct effects that can be explained include: (1) The direct effect of the activity system on renewable energy needs is  $(0.354)^2 = 0.1253$  or 12.53%; (2) The direct effect of changes in land use on the need for renewable energy is  $(0.328)^2 = 0.1076$  or 10.76%; and (3) The direct effect of space utilization allocation on renewable energy needs is  $(0.261)^2 = 0.0681$  or 6.81%. Furthermore, the indirect effects that can be explained are: (1) The indirect effect of the activity system through changes in land use on renewable energy needs is  $(0.354) \times (0.623) \times (0.328) = 0.0723$  or 7.23%; (2) The indirect effect of changes in land use through the activity system on renewable energy needs is  $(0.328) \times (0.623) \times (0.354) = 0.0723$  or 7.23%; (3) The indirect effect of the activity system through the allocation of space utilization on renewable energy needs is  $(0.354) \times (0.342) \times (0.261) = 0.0316$  or 3.16%; (4) The indirect effect of space utilization allocation through activity systems on energy demand is  $(0.261) \times (0.342) \times (0.354) = 0.0316$  or 3.16%; (5) The indirect effect of changes in land use through the allocation of space utilization on energy needs is  $(0.328) \times (0.567) \times (0.261) = 0.0485$  or 4.85%; and (6) The indirect effect of space utilization allocation through changes in land use on energy demand is  $(0.261) \times (0.567) \times (0.328) = 0.0485$  or 4.85%.

The effect of the total activity system, changes in land use, allocation of space use, on renewable energy needs is  $(0.1253) + (0.1076) + (0.0681) + (0.0723 + 0.0723) + (0.0316 + 0.0316) + (0.0485 + 0.0485) = 0.6058$  or 60.58%. Furthermore, the remaining effect or residue is  $1 - 0.6058 = 0.3942$  or 39.42%. The direct effect of renewable energy demand on improving environmental quality is  $(0.823)^2 = 0.6773$  or 67.73%, while the residual effect or residue (the effect of other variables) on improving environmental quality (not examined) is  $1 - 0.6773 = 0.3227$  or 32.27%. The results of this analysis can be concluded that there is a strengthening, namely the

effect of X on Y of 60.58% and the effect of Y on Z of 67.73%. That is, there was a strengthening from 60.58% to 67.73% (an increase of  $67.73 - 60.58 = 7.15\%$ ).

### 3.3. Renewable Energy and New City Development Sustainability

Increased socio-economic activity and allocation of spatial use for the new city of Moncongloe-Pattalassang, which is accompanied by the use of renewable energy, besides contributing to improving environmental quality, also has an impact on ecosystem stability. Energy saving through the use of renewable energy contributes to improving environmental quality and minimizing climate change (Iftikhar et al., 2022; Azam et al., 2023). Spatial dynamics that tend to develop towards increased productivity will simultaneously affect changes in land use and its impact on the conversion of productive agricultural land. The intensity of land use determines the provision of various ecosystem services that require policy implementation support from the government (Spörri et al., 2023). Furthermore, the use of new urban space is oriented towards meeting the need for housing and its population facilities and infrastructure. Thus, the use of renewable energy is strategic and important to optimize its utilization and synergize with the orientation of the future development of the new city of Moncongloe-Pattalassang. Several principles that need to be maximized in the use of renewable energy are the fulfillment of energy infrastructure, energy distribution, and energy availability when needed. This means that it is very important that the potential of renewable energy is maximized through investment support and the effectiveness of financial resources to support sustainable development (Barbosa et al., 2017; Boke et al., 2022). Efforts are needed to utilize and optimize the use of renewable energy, in order to ensure the stability of the ecosystem and the sustainability of the development of new city (Li et al., 2021; Anupong et al., 2023).

The sustainable development of the new city of Moncongloe-Pattalassang is oriented towards three main principles, namely: First, environmental sustainability, in the sense that all activities developed are synergized with efforts to save and control the environment through a balance between built and unbuilt areas and integrated with the fulfillment of green open spaces, limiting development on riverbanks, excessive use of groundwater sources, and saving water catchment areas. Water catchment area control is an important element in urban flood control (Szeląg et al., 2022).

Figure 15: Direct, indirect, and total influence

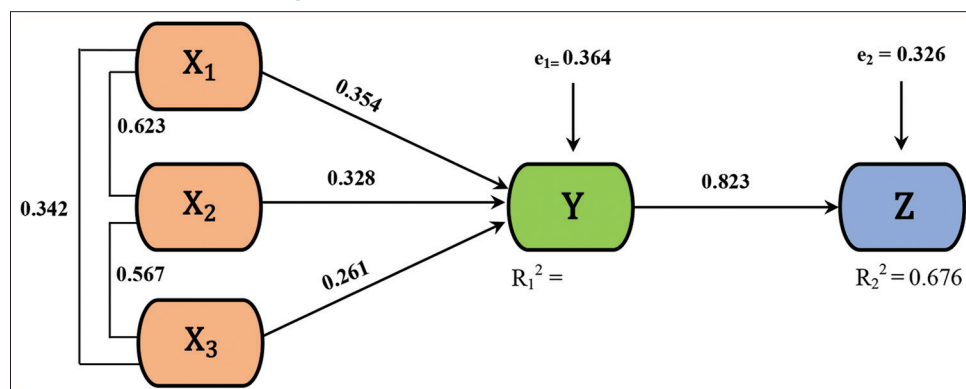

Second, economic sustainability, in the sense that the development of commercial activities is created to ensure equal distribution of economic services to the community towards a green economy, green building, equal distribution of economic enterprises, equal opportunities for economic actors and guaranteeing the quality of people’s lives. Reducing emissions coupled with sustainable economic growth will create social welfare (Chausson et al., 2023). Third, social sustainability, oriented towards creating social cohesion and harmony between immigrants and local residents. This process is carried out by reducing social distance, community segmentation, and gentrification through the implementation of government policies and support for community participation. The role of the community is an important part of the urban ecosystem to support saving the environment (Perera et al., 2023). Furthermore, a space utilization model based on the use of renewable energy and the sustainable development of the new city of Moncongloe-Pattalassang is presented in Figure 16 below.

Figure 16 shows a space utilization estimation model based on the use of renewable energy and the sustainability of the development of the new city of Moncongloe-Pattalassang. Interpretations proposed for the developed model include: First, the variables of space utilization, use of renewable energy, environmental quality, and restoration of environmental quality simultaneously affect the sustainability of the development of the new city of Moncongloe-Pattalassang. The results of the chi-square test showed a value of 123,442 with a probability of  $P = 0.135 > 0.05$ ,  $df = 92$ ,  $GFI = 0.761$ ,  $CFI = 0.643$ , and  $AGFI$

$= 0.502$ . These results confirm that the model built is categorized as a fit model. Second, the effect of space utilization allocation on the endogenous variable of renewable energy utilization is 0.2704 or 27.04%, the endogenous variable of utilization allocation on the exogenous variable of environmental quality restoration is 0.3025 or 30.25%, the endogenous variable of renewable energy utilization on the exogenous variable of environmental resilience is 0.2916 or 29.16%, environmental quality variable to environmental resilience exogenous variables of 0.7744 or 77.44%. Third, the variable allocation of space utilization to the sustainability of development is 0.5184 or 51.85%, the renewable energy utilization variable is to the sustainability of development by 0.0961 or 9.61%, the variable of environmental quality to the sustainability of development is 0.4761 or 47.61%. Fourth, the total influence of the allocation of space utilization and the use of renewable energy on the sustainability of new city development is 0.6241 or 62.41%. Thus, it can be concluded that the allocation of space utilization, utilization of renewable energy, and improvement of environmental quality simultaneously affect environmental resilience and the sustainability of the development of the new city of Moncongloe-Pattalassang. Utilization of renewable energy contributes to ecosystem stability and sustainable urban development (Andrianambinina et al., 2023).

Referring to the matters that have been explained, the strategic steps needed to support the sustainable development of the new city of Moncongloe-Pattalassang include: (1) Control of spatial use which is integrated with support for the preparation of renewable

**Figure 16:** Estimation of a space utilization model based on the use of renewable energy and the sustainability of the development of the new city of Moncongloe-Pattalassang

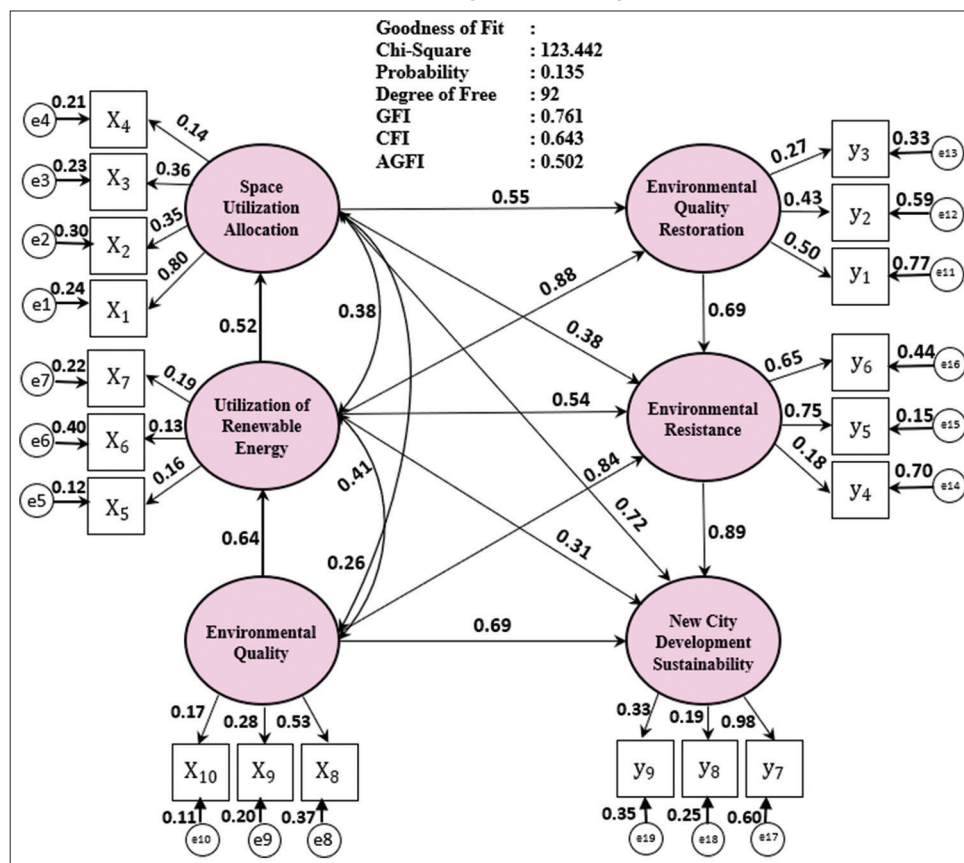

energy infrastructure in order to optimize the distribution of energy services; (2) Ensuring the balance and stability of the ecosystem through supporting the fulfillment of green open spaces based on community participation; (3) Ensuring the availability of renewable energy to support socio-economic activities of the community which are integrated with the restoration of environmental quality towards environmental resilience; and (4) Maximizing the service system for socio-economic activities and strengthening the protection of water catchment areas to support the sustainable development of the new city of Moncongloe-Pattalassang. These four things are developed optimally through support for the implementation of government policies whose implementation is carried out in a consistent, integrated manner, and involves development actors and stakeholders. This means that decision making from the government plays an important role in sustainable development (Delamou et al., 2023).

#### 4. CONCLUSION

An increase in population has a positive association with changes in land use towards the complexity of spatial use and dependence on the use of fossil energy which has an impact on reducing environmental quality. The decline in the environmental quality of the new city of Moncongloe-Pattalassang is marked by a fairly high pollution load and ecosystem instability. The complexity of the use of new urban space is in line with the increase in traffic volume, apart from having an impact on changes in land cover it also contributes to public health, decreases aesthetic values, economic losses, and disrupts environmental systems. This means that the allocation of space utilization, activity systems, and population mobility simultaneously have a positive effect on the energy needs of the new city of Moncongloe-Pattalassang. Thus, the potential for renewable energy has the opportunity to be exploited through the preparation of energy infrastructure that is placed in strategic locations and supports the future development of the new city of Moncongloe-Pattalassang.

Changes in land use for new cities are marked by the conversion of productive agricultural land towards increased socio-economic activity and is positively associated with a decrease in environmental quality. Efforts to control spatial use are needed that are integrated with optimizing the use of natural resources, environmental sustainability, and restoration of environmental quality based on the role of community participation. Furthermore, optimizing the management and utilization of renewable energy is oriented towards reducing the burden of pollution and environmental damage. Thus, the activity system, changes in land use, allocation of space use, have a positive effect on the demand for renewable energy needs to support improving the environmental quality of the new city of Moncongloe-Pattalassang.

The use of renewable energy is developed through the fulfillment of energy infrastructure, energy distribution, and energy availability which are synergized with sustainable development. Three main principles are needed to support the sustainable development of the new city of Moncongloe-Pattalassang, namely: Environmental sustainability, synergized with efforts to save and control the environment through a balance between built and

unbuilt areas and integrated with the fulfillment of green open spaces, limiting development to riverbank areas, excessive use of groundwater sources, and saving water catchment areas. Economic sustainability, created to guarantee an even distribution of economic services towards a green economy, green building, and economic equity, which guarantees the quality of people's lives. Social sustainability, oriented towards creating social cohesion and harmony between residents by reducing social distance, community segmentation, and supporting policy implementation from the government and community participation.

#### 5. FUNDING

We would like to thank the stakeholders who have provided ideas and ideas for the implementation of this study. Thank you to the Ministry of Education, Culture, Research and Technology of the Republic of Indonesia and Bosowa Foundation for their support and financial assistance in the implementation of this study.

#### REFERENCES

- Abdulla, H.M., Ibrahim, M.A. (2023), The impact of urban spatial plan on land value: An approach system to relating space syntax premises to the land price. *Sustainability*, 15, 7239.
- Abed Al Ahad, M., Demsar, U., Sullivan, F., Kulu, H. (2022), Air pollution and individuals' mental well-being in the adult population in United Kingdom: A spatial-temporal longitudinal study and the moderating effect of ethnicity. *PLoS One*, 17(3), e0264394.
- Adla, K., Dejan, K., Neira, D., Dragana, Š. (2022), Degradation of ecosystems and loss of ecosystem services. In: *One Health: Integrated Approach to 21<sup>st</sup> Century Challenges to Health*. Ch. 9. Netherlands: Elsevier. p281-327.
- Ait Sidhoum, A., Dakpo, K.H., Latruffe, L. (2022), Trade-offs between economic, environmental and social sustainability on farms using a latent class frontier efficiency model: Evidence for Spanish crop farms. *PLoS One*, 17(1), e0261190.
- Alhazzani, M., Alhasoun, F., Alawwad, Z., Gonza'lez, M.C. (2021), Urban attractors: Discovering patterns in regions of attraction in cities. *PLoS One*, 16(4), e0250204.
- Andrianambinina, F.O.D., Schuurman, D., Rakotoarijaona, M.A., Razanajovy, C.N., Ramparany, H.M., Rafanoharana, S.C., Faragher, K.D., Waeber, P.O., Wilmé, L. (2023), Boost the resilience of protected areas to shocks by reducing their dependency on tourism. *PLoS One*, 18(4), e0278591.
- Anupong, W., Muda, I., AbdulAmeer, S.A., Al-Kharsan, I.H., Alviz-Meza, A., Cárdenas-Escrocia, Y. (2023), Energy consumption and carbon dioxide production optimization in an educational building using the supported vector machine and ant colony system. *Sustainability*, 15, 3118.
- Atharinafi, Z., Wijaya, N. (2021), Land use change and its impacts on surface runoff in rural areas of the upper citarum watershed (case study: Cirasea Sub-watershed). *Journal of Regional and City Planning*, 32(1), 36-55.
- Azam, W., Khan, I., Ali, S.A. (2023), Alternative energy and natural resources in determining environmental sustainability: A look at the role of government final consumption expenditures in France. *Environmental Science and Pollution Research*, 30, 1949-1965.
- Bao, J., He, M. (2022), Does green credit promote green sustainable development in regional economies? Empirical evidence from 280 cities in China. *PLoS One*, 17(11), e0277569.
- Barbosa, L.S.N.S., Bogdanov, D., Vainikka, P., Breyer, C. (2017), Hydro,



- wind and solar power as a base for a 100% renewable energy supply for South and Central America. *PLoS One*, 12(3), e0173820.
- Boke, M.T., Moges, S.A., Dejen, Z.A. (2022), Optimizing renewable-based energy supply options for power generation in Ethiopia. *PLoS One*, 17(1), e0262595.
- Caperon, L., Saville, F., Ahern, S. (2022), Developing a socio-ecological model for community engagement in a health programme in an underserved urban area. *PLoS One*, 17(9), e0275092.
- Cavelius, P., Engelhart-Straub, S., Mehlmer, N., Lercher, J., Awad, D., Brück, T. (2023), The potential of biofuels from first to fourth generation. *PLoS Biology*, 21(3), e3002063.
- Chausson, A., Welden, E.A., Melanidis, M.S., Gray, E., Hirons, M., Seddon, N. (2023), Going beyond market-based mechanisms to finance nature-based solutions and foster sustainable futures. *PLoS Climate*, 2(4), e0000169.
- Chen, Y., Ji, X., Lai, Q. (2022), Research on the temporal evolution track and influence of green development from 2010 to 2019. *PLoS One*, 17(11), e0263482.
- Cochran, W.G. (1991), *Teknik Penarikan Sampel. Edisi Ketiga*. Depok: Penerbit Universitas Indonesia. Available from: <https://lib.ui.ac.id/detail.jsp?id=20103076> [Last accessed on 2023 May 05].
- Delamou, A., Grovogui, F.M., Miller, L., Nye, A., Kourouma, M., Kolie, D., Goumou, T., Bossert, T.J. (2023), Implementation research protocol on the national community health policy in Guinea: A sequential mixed-methods study using a decision space approach. *PLoS One*, 18(1), e0280651.
- Gao, Q.L., Li, Q.Q., Zhuang, Y., Yue, Y., Liu, Z.Z., Li, S.Q., Sui, D. (2019), Urban commuting dynamics in response to public transit upgrades: A big data approach. *PLoS One*, 14(10), e0223650.
- Gyimah, J., Hayford, I.S., Nwigwe, U.A., Opoku, E.O. (2023), The role of energy and economic growth towards sustainable environment through carbon emissions mitigation. *PLoS Climate*, 2(3), e0000116.
- Hanif, S., Lateef, M., Hussain, K., Hyder, S., Usman, B., Zaman, K., Asif, M. (2022), Controlling air pollution by lowering methane emissions, conserving natural resources, and slowing urbanization in a panel of selected Asian economies. *PLoS One*, 17(8), e0271387.
- He, Y., Wei, W. (2023), Renewable energy consumption: Does it matter for China's sustainable development? *Energies*, 16, 1242.
- Iftikhar, H., Pinglu, C., Ullah, S., Ullah, A. (2022), Impact of tourism on sustainable development in BRI countries: The moderating role of institutional quality. *PLoS One*, 17(4), e0263745.
- Kalfas, D., Kalogiannidis, S., Chatzitheodoridis, F., Toska, E. (2023), Urbanization and land use planning for achieving the sustainable development goals (SDGs): A case study of Greece. *Urban Science*, 7, 43.
- Kariuki, R.W., Munishi, L.K., Courtney-Mustaphi, C.J., Capitani, C., Shoemaker, A., Lane, P.J., Marchant, R. (2021), Integrating stakeholders' perspectives and spatial modelling to develop scenarios of future land use and land cover change in northern Tanzania. *PLoS One*, 16(2), e0245516.
- Khalil, L., Abbas, S., Hussain, K., Zaman, K., Iswan, Salamun, H., Hassan, Z.B., Anser, M.K. (2022), Sanitation, water, energy use, and traffic volume affect environmental quality: Go-for-green developmental policies. *PLoS One*, 17(8), e0271017.
- Kisiała, W., Račka, I. (2021), Spatial and statistical analysis of urban poverty for sustainable city development. *Sustainability*, 13, 858.
- Li, B., Liu, Q., Li, Y., Zheng, S. (2023), Socioeconomic productive capacity and renewable energy development: Empirical insights from BRICS. *Sustainability*, 15, 5986.
- Li, L., Zhao, N. (2023), Understanding urban concentration of complex manufacturing activities in China. *PLoS One*, 18(3), e0278469.
- Li, T., Li, A., Song, Y. (2021), Development and utilization of renewable energy based on carbon emission reduction-evaluation of multiple MCDM methods. *Sustainability*, 13, 9822.
- Lovering, J., Swain, M., Blomqvist, L., Hernandez, R.R. (2022), Land-use intensity of electricity production and tomorrow's energy landscape. *PLoS One*, 17(7), e0270155.
- Lu, Y., Yang, S., Li, J. (2022), The influence of high-speed rails on urban innovation and the underlying mechanism. *PLoS One*, 17(3), e0264779.
- Majeed, A., Ye, C., Chenyun, Y., Wei, X., Muniba. (2022), Roles of natural resources, globalization, and technological innovations in mitigation of environmental degradation in BRI economies. *PLoS One*, 17(6), e0265755.
- Marcantonio, R., Javeline, D., Field, S., Fuentes, A. (2021), Global distribution and coincidence of pollution, climate impacts, and health risk in the anthropocene. *PLoS One*, 16(7), e0254060.
- Mustafa, S., Zhang, W., Sohail, M.T., Rana, S., Long, Y. (2023), A moderated mediation model to predict the adoption intention of renewable wind energy in developing countries. *PLoS One*, 18(3), e0281963.
- Mwale, M., Luke, R., Pisa, N. (2022), Factors that affect travel behaviour in developing cities: A methodological review. *Transportation Research Interdisciplinary Perspectives*, 16, 100683.
- Ortega-Gil, M., Cortés-Sierra, G., ElHichou-Ahmed, C. (2021), The effect of environmental degradation, climate change, and the European green deal tools on life satisfaction. *Energies*, 14, 5839.
- Oskouei, M.Z., Seker, A.A., Tunçel, S., Demirbas, E., Gözel, T., Hocaoglu, M.H., Abapour, M., Mohammadi-Ivatloo, B. (2022), A critical review on the impacts of energy storage systems and demand-side management strategies in the economic operation of renewable-based distribution network. *Sustainability*, 14, 2110.
- Perera, E.D., Moglia, M., Glackin, S. (2023), Beyond "community-washing": Effective and sustained community collaboration in urban waterways management. *Sustainability*, 15, 4619.
- Purnamawati, I.G.A., Yuniarta, G.A., Jie, F. (2023), Strengthening the role of corporate social responsibility in the dimensions of sustainable village economic development. *Heliyon*, 9(4), e15115.
- Qi, Z., Yang, S., Feng, D., Wang, W. (2022), The impact of local government debt on urban environmental pollution and its mechanism: Evidence from China. *PLoS One*, 17(3), e0263796.
- Rai, M.K., Paudel, B., Zhang, Y., Nepal, P., Khanal, N.R., Liu, L., Rai, R. (2023), Appraisal of empirical studies on land-use and land-cover changes and their impact on ecosystem services in Nepal Himalaya. *Sustainability*, 15, 7134.
- Rashedi, A., Gul, N., Hussain, M., Hadi, R., Khan, N., Nadeem, S.G., Khanam, T., Asyraf, M.R.M., Kumar, V. (2022), Life cycle environmental sustainability and cumulative energy assessment of biomass pellets biofuel derived from agroforest residues. *PLoS One*, 17(10), e0275005.
- Shabani, T., Jerie, S. (2023), A review of the applicability of environmental management systems in waste management in the medical sector of Zimbabwe. *Environmental Monitoring and Assessment*, 195, 789.
- Sharma, S., Agarwal, S., Jain, A. (2021), Significance of hydrogen as economic and environmentally friendly fuel. *Energies*, 14, 7389.
- Sim, L.C. (2023), Renewable energy and governance resilience in the gulf. *Energies*, 16, 3225.
- Spörri, M., El Benni, N., Mack, G., Finger, R. (2023), Spatio-temporal dynamics of grassland use intensity in Switzerland. *Regional Environmental Change*, 23, 23.
- Strielkowski, W., Civin, L., Tarkhanova, E., Tvaronavičienė, M., Petrenko, Y. (2021), Renewable energy in the sustainable development of electrical power sector: A review. *Energies*, 14, 8240.
- Surya, B., Ahmad, D.N.A., Sakti, H.H., Sahban, H. (2020), Land use change, spatial interaction, and sustainable development in the metropolitan Urban Areas, South Sulawesi Province, Indonesia.

- Land, 9(3), 95.
- Surya, B., Hadijah, H., Suriani, S., Baharuddin, B., Fitriyah, A.T., Menne, F., Rasyidi, E.S. (2020), Spatial transformation of a New City in 2006-2020: Perspectives on the spatial dynamics, environmental quality degradation, and socio-economic sustainability of local communities in Makassar City, Indonesia. *Land*, 9(9), 324.
- Surya, B., Hamsina, H., Ridwan, R., Baharuddin, B., Menne, F., Fitriyah, A.T., Rasyidi, E.S. (2020), The complexity of space utilization and environmental pollution control in the main corridor of Makassar City, South Sulawesi, Indonesia. *Sustainability*, 12(21), 9244.
- Surya, B., Muhibuddin, A., Suriani, S., Rasyidi, E.S., Baharuddin, B., Fitriyah, A.T., Abubakar, H. (2021), Economic evaluation, use of renewable energy, and sustainable urban development Mamminasata Metropolitan, Indonesia. *Sustainability*, 13, 1165.
- Surya, B., Saleh, H., Suriani, S., Sakti, H.H., Hadijah, H., Idris, M. (2020), Environmental pollution control and sustainability management of slum settlements in Makassar City, South Sulawesi, Indonesia. *Land*, 9(9), 279.
- Surya, B., Salim, A., Hernita, H., Suriani, S., Menne, F., Rasyidi, E.S. (2021), Land use change, urban agglomeration, and Urban Sprawl: A sustainable development perspective of Makassar City, Indonesia. *Land*, 10, 556.
- Surya, B., Salim, A., Saleh, H., Abubakar, H., Suriani, S., Sose, A.T., Kessi, A.M.P. (2021), Economic growth model and renewable energy utilization: Perspective of natural resources management and sustainable development of the Gowa regency Region South Sulawesi, Indonesia. *International Journal of Energy Economics and Policy*, 11(6), 68-90.
- Surya, B., Salim, A., Saleh, H., Suriani, S., Yunus, K., Taibe, P. (2022), Population mobility and urban transport management: Perspectives environmental quality degradation and sustainable development of suburban Makassar City, Indonesia. *Hungarian Geographical Bulletin*, 71(4), 383-400.
- Surya, B., Salim, A., Suriani, S., Menne, F., Rasyidi, E.S. (2021), Economic growth and development of a Minapolitan area based on the utilization of renewable energy, Takalar Regency, South Sulawesi, Indonesia. *International Journal of Energy Economics and Policy*, 11(5), 255-274.
- Surya, B., Suriani, S., Menne, F., Abubakar, H., Idris, M., Rasyidi, E.S., Remmang, H. (2021), Community empowerment and utilization of renewable energy: Entrepreneurial perspective for community resilience based on sustainable management of slum settlements in Makassar City, Indonesia. *Sustainability*, 13, 3178.
- Surya, B., Syafri, S., Sahban, H., Sakti, H.H. (2020), Natural resource conservation based on community economic empowerment: Perspectives on watershed management and slum settlements in Makassar City, South Sulawesi, Indonesia. *Land*, 9(4), 104.
- Surya, B., Taibe, P., Sariman, S., Hernita, H., Salim, A., Nasrullah, N., Zubair, A.G.H. (2023), Renewable energy utilization and environmental pollution control in the New City Area Mamminasata Metropolitan, Indonesia. *International Journal of Energy Economics and Policy*, 13(1), 213-226.
- Szeląg, B., Suligowski, R., Łagód, G., Łazuka, E., Wlaz, P., Stránský, D., De Paola, F., Fatone, F. (2022), Flood occurrence analysis in small urban catchments in the context of regional variability. *PLoS One*, 17(11), e0276312.
- Tagwi, A. (2022), The impacts of climate change, carbon dioxide emissions (CO<sub>2</sub>) and renewable energy consumption on agricultural economic growth in South Africa: ARDL approach. *Sustainability*, 14, 16468.
- Tejada-Gutiérrez, E.L., Koloszko-Chomentowska, Z., Fiore, M., Spada, A. (2023), Sustainable environmental development from the regional perspective-the interesting case of Poland. *Sustainability*, 15, 4368.
- Teston, A., Piccinini Scolaro, T., Kuntz Maykot, J., Ghisi, E. (2022), Comprehensive environmental assessment of rainwater harvesting systems: A literature review. *Water*, 14, 2716.
- Vo, D.H., Tran, Q., Tran, T. (2022), Economic growth, renewable energy and financial development in the CPTPP countries. *PLoS One*, 17(6), e0268631.
- Wang, C., Cardon, P.W., Liu, J., Madni, G.R. (2020), Social and economic factors responsible for environmental performance: A global analysis. *PLoS One*, 15(8), e0237597.
- Wang, Y., Zhao, R., Li, Y., Yao, R., Wu, R., Li, W. (2023), Research on the evolution and the driving forces of land use classification for production, living, and ecological space in China's Qilian Mountains Nature Reserve from 2000 to 2020. *Environmental Science and Pollution Research*, 30, 64949-64970.
- Warrington, S., Layton, A. (2022), Ecosystem guidance for the incorporation of renewable utilities in a multi-use campus network. *PLoS One*, 17(5), e0267431.
- Wu, W., Lin, Y. (2022), The impact of rapid urbanization on residential energy consumption in China. *PLoS One*, 17(7), e0270226.
- Wu, Y., Gu, C., Zhang, Y. (2022), Towards sustainable management of urban ecological space: A zoning approach hybridized by ecosystem service value and ecological risk assessment. *Land*, 11, 1220.
- Wu, Z., Tian, G., Han, X., Li, J., Xia, Q. (2023), Can the water resources tax policy effectively stimulate the water saving behavior of social water users? A DSGE model embedded in water resources tax. *PLoS One*, 18(3), e0281920.
- Xiao, L., Ding, H., Zhong, Y., Wang, C. (2023), Optimal control of industrial pollution under stochastic differential models. *Sustainability*, 15, 5609.
- Yang, Z., Fu, L., Chen, Y. (2023), Digital economy and pollution reduction-mechanism and regional heterogeneity. *PLoS One*, 18(2), e0277852.
- Yao, X., Yasmeen, R., Padda, I.U.H., Shah, W.U.H., Kamal, M.A. (2020), Inequalities by energy sources: An assessment of environmental quality. *PLoS One*, 15(3), e0230503.
- Yasir, N., Babar, M., Mehmood, H.S., Xie, R., Guo, G. (2023), The environmental values play a role in the development of green entrepreneurship to achieve sustainable entrepreneurial intention. *Sustainability*, 15, 6451.